



Operation Manual

Solenoid Valve

PRODUCT NAME

VQ1000/2000 Series
(PILOT VALVE : V100)

MODEL/ Series

SMC Corporation

Contents

Safety Instructions	2,3
Precautions on Design	4,5
Selection	4,5
Mounting	5
Piping	6
Wiring	6
Lubrication	6
Air Supply	7
Operating Environment	7
Maintenance	7,8
Specific Product Precautions	9,10,11
Trouble shooting	12,13



Safety Instructions

These safety instructions are intended to prevent hazardous situations and/or equipment damage. These instructions indicate the level of potential hazard with the labels of "Caution," "Warning" or "Danger." They are all important notes for safety and must be followed in addition to International Standards (ISO/IEC)*1), and other safety regulations.

*1) ISO 4414: Pneumatic fluid power -- General rules relating to systems.

ISO 4413: Hydraulic fluid power -- General rules relating to systems.

IEC 60204-1: Safety of machinery -- Electrical equipment of machines .(Part 1: General requirements)

ISO 10218: Manipulating industrial robots -Safety.

etc.



Caution

Caution indicates a hazard with a low level of risk which, if not avoided, could result in minor or moderate injury.



Warning

Warning indicates a hazard with a medium level of risk which, if not avoided, could result in death or serious injury.



Danger

Danger indicates a hazard with a high level of risk which, if not avoided, will result in death or serious injury.

Warning

1. The compatibility of the product is the responsibility of the person who designs the equipment or decides its specifications.

Since the product specified here is used under various operating conditions, its compatibility with specific equipment must be decided by the person who designs the equipment or decides its specifications based on necessary analysis and test results.

The expected performance and safety assurance of the equipment will be the responsibility of the person who has determined its compatibility with the product.

This person should also continuously review all specifications of the product referring to its latest catalog information, with a view to giving due consideration to any possibility of equipment failure when configuring the equipment.

2. Only personnel with appropriate training should operate machinery and equipment.

The product specified here may become unsafe if handled incorrectly.

The assembly, operation and maintenance of machines or equipment including our products must be performed by an operator who is appropriately trained and experienced.

3. Do not service or attempt to remove product and machinery/equipment until safety is confirmed.

1. The inspection and maintenance of machinery/equipment should only be performed after measures to prevent falling or runaway of the driven objects have been confirmed.

2. When the product is to be removed, confirm that the safety measures as mentioned above are implemented and the power from any appropriate source is cut, and read and understand the specific product precautions of all relevant products carefully.

3. Before machinery/equipment is restarted, take measures to prevent unexpected operation and malfunction.

4. Contact SMC beforehand and take special consideration of safety measures if the product is to be used in any of the following conditions.

1. Conditions and environments outside of the given specifications, or use outdoors or in a place exposed to direct sunlight.

2. Installation on equipment in conjunction with atomic energy, railways, air navigation, space, shipping, vehicles, military, medical treatment, combustion and recreation, or equipment in contact with food and beverages, emergency stop circuits, clutch and brake circuits in press applications, safety equipment or other applications unsuitable for the standard specifications described in the product catalog.

3. An application which could have negative effects on people, property, or animals requiring special safety analysis.

4. Use in an interlock circuit, which requires the provision of double interlock for possible failure by using a mechanical protective function, and periodical checks to confirm proper operation.



Safety Instructions

Caution

1. The product is provided for use in manufacturing industries.

The product herein described is basically provided for peaceful use in manufacturing industries.

If considering using the product in other industries, consult SMC beforehand and exchange specifications or a contract if necessary.

If anything is unclear, contact your nearest sales branch.

Limited warranty and Disclaimer/Compliance Requirements

The product used is subject to the following "Limited warranty and Disclaimer" and "Compliance Requirements".

Read and accept them before using the product.

Limited warranty and Disclaimer

1. The warranty period of the product is 1 year in service or 1.5 years after the product is delivered, whichever is first.*2)

Also, the product may have specified durability, running distance or replacement parts. Please consult your nearest sales branch.

2. For any failure or damage reported within the warranty period which is clearly our responsibility, a replacement product or necessary parts will be provided.

This limited warranty applies only to our product independently, and not to any other damage incurred due to the failure of the product.

3. Prior to using SMC products, please read and understand the warranty terms and disclaimers noted in the specified catalog for the particular products.

***2) Vacuum pads are excluded from this 1 year warranty.**

A vacuum pad is a consumable part, so it is warranted for a year after it is delivered.

Also, even within the warranty period, the wear of a product due to the use of the vacuum pad or failure due to the deterioration of rubber material are not covered by the limited warranty.

Compliance Requirements

1. The use of SMC products with production equipment for the manufacture of weapons of mass destruction(WMD) or any other weapon is strictly prohibited.

2. The exports of SMC products or technology from one country to another are governed by the relevant security laws and regulation of the countries involved in the transaction. Prior to the shipment of a SMC product to another country, assure that all local rules governing that export are known and followed.

Caution

SMC products are not intended for use as instruments for legal metrology.

Measurement instruments that SMC manufactures or sells have not been qualified by type approval tests relevant to the metrology (measurement) laws of each country.

Therefore, SMC products cannot be used for business or certification ordained by the metrology (measurement) laws of each country.



Precautions for 5 Port Solenoid Valve ①

Be sure to read before handling. Refer to main text for detailed precautions on every series.

Design / Selection

⚠ Warning

1. Confirm the specifications

Products represented in this instruction manual are designed only for use in compressed air systems (including vacuum).

Do not operate at pressures or temperatures, etc., beyond the range of specifications, as this can cause damage or malfunction.

We do not guarantee against any damage if the product is used outside of the specification range.

2. Actuator drive

When an actuator, such as a cylinder, is to be driven using a valve, take appropriate measures (cover installation or approach prohibition) to prevent potential danger caused by actuator operation.

3. Intermediate stops

For 3-position closed center or double check valve type, it is difficult to make a piston stop at the required position accurately due to the compressibility of air.

Furthermore, since valves and cylinders are not guaranteed for zero air leakage, it may not be possible to hold a stopped position for an extended period of time. Please contact SMC if it is necessary to hold a stopped position for an extended period of time.

4. Effect of back pressure when using a manifold.

Use caution when valves are used on a manifold, because an actuator may malfunction due to back-pressure. For 3-position exhaust center valve of single acting cylinder, take appropriate measures to prevent the malfunction by using it with an individual exhaust manifold.

5. Holding pressure (including vacuum).

Since the valve are subject to air leakage, they cannot be used for applications such as holding pressure (including vacuum) in a pressure vessel.

6. Not suitable for use as an emergency shut-off valve, etc.

The valves listed in this instruction manual are not designed for safety applications such as an emergency shutoff valve. If the valves are used for the mentioned applications, additional safety measures should be adopted.

7. Release of residual pressure

For maintenance purposes install a system for releasing residual pressure. Especially in the case of 3-position closed center valve or double check valve type, ensure that the residual pressure between the valve and the cylinder is released.

8. Ventilation

Provide ventilation when using a valve in a confined area, such as in a closed control panel. For example, install a ventilation opening, etc. in order to prevent pressure from increasing inside of the confined area and to release the heat generated by the valve.

9.Regarding a vacuum switch valve

For maintenance purposes install a system for releasing residual pressure.

10. Double solenoid type

When using the double solenoid type for the first time, actuators may travel in an unexpected direction depending on the switching position of the valve. Implement measures to prevent any danger from occurring when operating the actuator.

11. Ventilation

Provide ventilation when using a valve in a confined area, such as in a closed control panel. For example, install a ventilation opening, etc. in order to prevent pressure from increasing inside of the confined area and to release the heat generated by the valve.

12.Do not disassemble the product of make any modifications, including additional machining.

It may cause human injury and/or an accident.

⚠ Caution

1. Momentary energization

If a double solenoid valve is operated with momentary energization, it should be energized for at least 0.1 second. However, depending on the condition of the secondary load, it should be energized until the cylinder reaches the stroke end position, since there is a possibility of malfunction.

2. Leakage voltage

Take note that the leakage voltage will increase when a resistor is used in parallel with switching element or a C-R circuit (surge voltage suppressor) is used for protecting a switching device because of the passing leakage voltage through the C-R circuit.

The suppressor residual leakage voltage should be as follows.

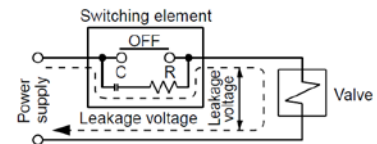

DC coil

Should be 3% or less of the rated voltage.

AC coil

Should be 8% or less of the rated voltage.



Precautions for 5 Port Solenoid Valve ②

Be sure to read before handling. Refer to main text for detailed precautions on every series.

Design / Selection

Caution

3. Solenoid valve drive for AC with solid state output (SSR, TRIAC output, etc.)

1) Current leakage

When using a snubber circuit (C-R element) for surge protection of the output, a very small amount of electrical current will continue to flow even during the OFF state. This results in the valve not returning. In the a situation where the tolerance is exceeded, as in the above case, take measures to install a bleeder resistor.

2) Minimum allowable load amount (Min. load current)

When the consumption current of a valve is less than the output's minimum allowable load volume or the margin is small, the output may not switch normally. Please contact SMC.

4. Surge voltage suppressor

If a surge protection circuit contains nonstandard diodes, such as Zener diodes or varistor, a residual voltage that is in proportion to the protective circuit and the rated voltage will remain. Therefore, take into consideration the surge voltage protection of the controller. In the case of diodes, the residual voltage is approximately 1 V.

5. Operation in a low temperature condition

It is possible to operate a valve in extreme temperature, as low as -10 °C. Take appropriate measures to avoid freezing of drainage, moisture etc. in low temperature.

6. Mounting orientation

Rubber seal : Mounting orientation is free.

Metal seal : Mounting orientation of a single solenoid is universal.

No specific orientation is necessary. When installing a double solenoid or a 3-position configuration, mount the valve so that spool valve is horizontal.

Mounting

Warning

1. Operation manual

Install the products and operate them only after reading the operation manual carefully and understanding its contents. Also, keep the manual where it can be referred to as necessary.

2. Ensure sufficient space for maintenance activities.

When installing the products, allow access for maintenance.

3. Tighten threads with the proper tightening torque.

When installing the products, follow the listed torque specifications.

4. If air leakage increases or equipment does not operated properly, stop operation.

Check mounting conditions when air and power supplies are connected. Initial function and leakage tests should be performed after installation.

5. Painting and coating

Warnings or specifications printed or affixed to the product should not be erased, removed or covered up. Please consult with SMC before applying paint to resinous parts, as this may have an adverse effect due to the solvent in the paint.



VQ1000/2000 Series

Precautions for 5 Port Solenoid Valve ③

Be sure to read before handling. Refer to main text for detailed precautions on every series.

Piping

⚠ Caution

1. Refer to the Fittings and Tubing Precautions for handling one-touch fittings.

2. Preparation before piping

Before piping is connected, it should be thoroughly blown out with air (flushing) or washed to remove chips, cutting oil and other debris from inside the pipe.

3. Wrapping of pipe tape

When screwing piping or fittings into ports, ensure that chips from the pipe threads or sealing material do not enter the piping. Also, if pipe tape is used, leave 1 thread ridges exposed at the end of the threads.

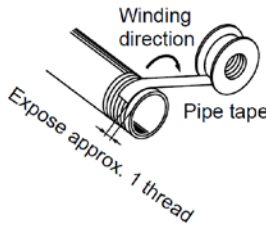

4. Closed center

For closed center, check the piping to prevent air leakage from the piping between the valve and the cylinder.

5. Connection of fittings

When screwing fittings into valves, tighten as follows.

(1) Follow the procedures below when installing an SMC fitting, etc.

1) M5 types

After tightening the fitting by hand, use a wrench to tighten the fitting an additional approximately 1/6 to 1/4 turn. As a reference value, tightening torque is 1 to 1.5 N·m.

Note) If tightened excessively, the thread of the product may break or the gasket may deform. If tightened insufficiently, the thread of the product may become loose. In either case, air leakage can occur.

(2) Follow the procedure of the manufacture when fittings other than SMC is used.

6. Piping to products

When piping to a product, avoid mistakes regarding the supply port, etc.

Wiring

⚠ Caution

1. Polarity

When connecting power to a solenoid valve with a DC specification and equipped with a light or surge voltage suppressor, check for polarity. If there is polarity, take note of the following.

No diode to protect polarity.

If a mistake is made regarding the polarity, damage may occur to the diode in the valve, the switching element in a control device or power supply equipment, etc.

With diode to protect polarity.

If polarity connection is wrong, the valve does not operate.

2. Applied voltage

When electric power is connected to a solenoid valve, be careful to apply the proper voltage. Improper voltage may cause malfunction or coil damage.

3. Check the connections.

Check if the connections are correct after completing all wiring.

Lubrication

⚠ Warning

1. Lubrication

[Rubber seal]

1) The valve has been lubricated for life by the factory and does not require any further.

2) If a lubricant is used in the system, use class 1 turbine oil (no additive), ISO VG32.

Once a lubricant is used in the system, lubrication must be continued because the original lubricant applied during manufacturing will be washed away.

If turbine oil is used, refer to the Material Safety Data Sheet (MSDS) of the oil.

[Rubber seal]

1) These valves can be used without lubrication.

2) If lubricant is used in the system, use class 1 turbine oil (no additive), ISO VG32.

If turbine oil is used, refer to the Material Safety Date Sheet (MSDS) of the oil.

Class 1 Turbine Oil (with no additive), ISO VG32

Lubricant manufacturer	Class 1 turbine oil (with no additive), ISO VG32.
Idemitsu Kosan Co. Ltd.	Diana Fresia S32
Nippon Oil Corp.	Turbine Oil 32
Cosmo Oil Co. Ltd.	Cosmo Turbine 32
Jpan Energy Corp.	Turbine 32
Kygnus Oil Co.	Turbine Oil 32
Fuji Kosan Co., Ltd.	Fucoal Turbine 32

Please contact SMC regarding class 2 turbine oil (with additives), ISO VG32.



Precautions for 5 Port Solenoid Valve ④

Be sure to read before handling. Refer to main text for detailed precautions on every series.

Air Supply

Warning

1. Type of fluids

Please consult with SMC when using the product in applications other than compressed air.

2. When there is a large amount of drainage.

Compressed air containing a large amount of drainage can cause malfunction of pneumatic equipment. An air dryer or water separator should be installed upstream from filters.

3. Drain flushing

If condensation in the drain bowl is not emptied on a regular basis, the bowl will overflow and allow the condensation to enter the compressed air lines. It causes malfunction of pneumatic equipment. If the drain bowl is difficult to check and remove, installation of a drain bowl with an auto drain option is recommended.

For compressed air quality, refer to SMC's Best Pneumatics catalog.

4. Use clean air

Do not use compressed air that contains chemicals, synthetic oils including organic solvents, salt or corrosive gasses, etc., as it can cause damage or malfunction.

Caution

1. When extremely dry air is used as the fluid, degradation of the lubrication properties in side the equipment may occur, resulting in reduced reliability (or reduced service life) of the equipment. Please consult with SMC.

2. Install an air filter.

Install an air filter upstream near the valve. Select an air filter with a filtration size of 5 µm or smaller.

3. Take measures to ensure air quality, such as by installing an aftercooler, air dryer, or water separator.

Compressed air that contains a large amount of drainage can cause malfunction of pneumatic equipment such as valves. Therefore, take appropriate measures to ensure air quality, such as by providing an aftercooler, air dryer, or water separator.

4. If excessive carbon powder is seen, install a mist separator on the upstream side of the valve.

If excessive carbon dust is generated by the compressor, it may adhere to the inside of a valve and cause it to malfunction.

For compressed air quality, refer to SMC's Best Pneumatics catalog.

Operating Environment

Warning

1. Do not use in an atmosphere having corrosive gases, chemicals, sea water, water, water steam, or where there is direct contact with any of these .
2. Products with IP65 enclosures (based on IEC60529) are protected against dust and water, however, these products cannot be used in water.
3. Products compliant to IP65 satisfy the specifications through mounting. Be sure to read the Precautions for each product.
4. Do not use in an environment where flammable gas or explosive gas exists. Usage may cause a fire or explosion. The products do not have an explosion proof construction.
5. Do not use in a place subject to heavy vibration and/or shock.
6. The valve should not be exposed to prolonged sunlight. Use a protective cover.
7. Remove any sources of excessive heat.
8. If it is used in an environment where there is possible contact with oil, weld spatter, etc., exercise preventive measures.
9. When the valve is mounted in a control panel or its energized for a long time, make sure ambient temperatures is within the specification of the valve.

Maintenance

Warning

1. Perform maintenance inspection according to the procedures indicated in the operation manual.

If handled improperly, malfunction and damage of machinery or equipment may occur.

2. Removal of equipment, and supply/exhaust of compressed air

When components are removed, first confirm that measures are in place to prevent workpieces from dropping, run-away equipment, etc. Then, cut off the supply pressure and electric power, and exhaust all compressed air from the system using the residual pressure release function.

For 3-position closed center type, exhaust the residual pressure between the valve and the cylinder. When the equipment is operated after remounting or replacement, first confirm that measures are in place to prevent lurching of actuators, etc. Then, confirm that the equipment is operating normally.

3. Low frequency operation

Valves should be operated at least once every 30 days to prevent malfunction. (Use caution regarding the air supply.)

4. Manual override operation

When the manual override is operated, connected equipment will be actuated.

Operate after safety is confirmed.



VQ1000/2000 Series

Precautions for 5 Port Solenoid Valve ⑤

Be sure to read before handling. Refer to main text for detailed precautions on every series.

Caution

1. Drain flushing

Remove drainage from the air filters regularly.

2. Lubrication

In the case of rubber seals, once lubrication has been started, it must be continued.

Use class 1 turbine oil (with no additive), VG32 because if other lubricant oil is used, it may cause malfunction. Please contact SMC for suggested class 2 turbine oil (with additive), VG32.



VQ1000/2000 series Specific Product Precautions 1

Be sure to read this before handling

Light/Surge Voltage Suppressor

⚠ Caution

The lighting positions are concentrated on one side for both single solenoid type and double solenoid type. In the double solenoid type, A side and B side energization are indicated by two colors which match the colors of the manual overrides.

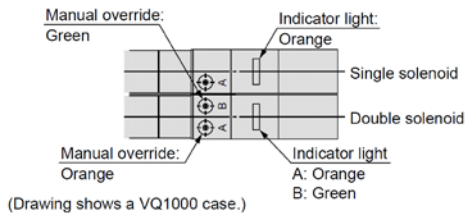

DC circuit diagram

Single solenoid

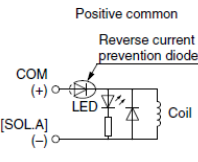

Double solenoid

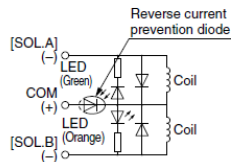

Note) A-side energization: A light (Orange) illuminates.
B-side energization: B light (Green) illuminates.

With wrong wiring prevention (stop diode) mechanism
With a surge absorption (surge absorption diode) mechanism

Manual Override

⚠ Warning

Without an electric signal for the solenoid valve the manual override is used for switching the main valve. Push type is standard. (Tool required) Locking type is semi-standard. (Tool required/Manual)

■ Push type (Tool required)

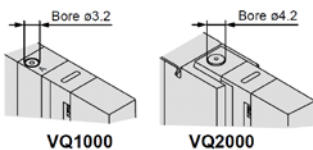

Push down on the manual override with a small screwdriver, etc. until it stops. Release the screwdriver and the manual override will return.

■ Locking type (Tool required) <Semi-standard>

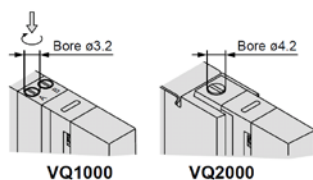

Push down on the manual override with a flat head screwdriver until it stops. Turn it clockwise by 90° to lock it. Turn it counterclockwise to release it.

■ Locking type (Manual) <Semi-standard>

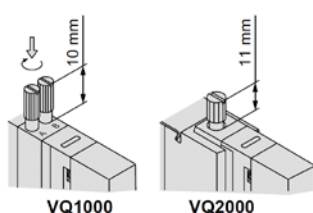

Push down on the manual override with a small flat head screwdriver or with your fingers until it stops. Turn it clockwise by 90° to lock it. Turn it counterclockwise to release it.

⚠ Caution

Do not apply excessive torque when turning the locking type manual override. (0.1 N·m or less)

⚠ Warning

■ Slide locking type (Manual) <Semi-standard>

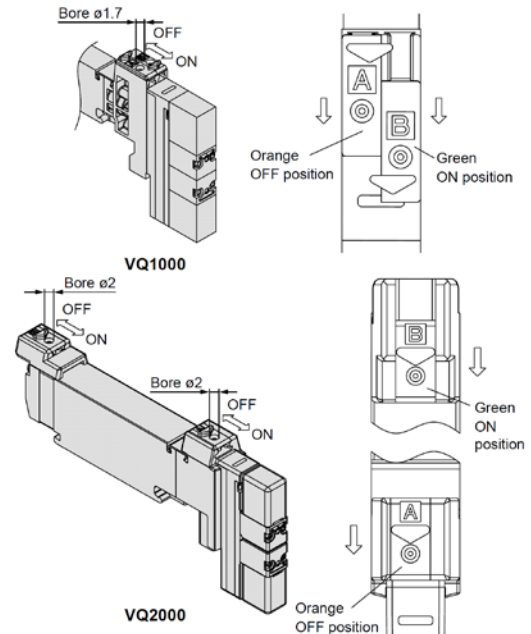

The manual override is locked by sliding it all the way to the pilot valve side (ON side) with a small flat head screwdriver or finger. Slide it to the fitting side (OFF side) to release it. In addition, it can also be used as a push type by using a screwdriver, etc., of ø1.7 or less. (ø2 or less for VQ2000).

How to Mount/Remove Solenoid Valves

⚠ Caution

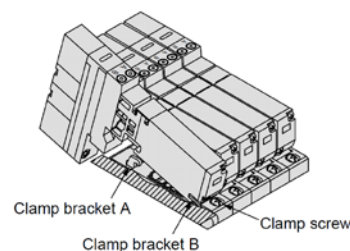

Removing

1. Loosen the clamp screw until it turns freely. (The screw is captive.)
2. Lift the coil side of the valve body while pressing down slightly on the screw head and remove it from the clamp bracket B. When the screw head cannot be pressed easily, gently press the area near the manual override of the valve.



VQ1000/2000 series Specific Product Precautions 2

Be sure to read this before handling

How to Mount/Remove Solenoid Valves

⚠ Caution

Mounting

1. Press down on the clamp screw. Clamp bracket A opens. Diagonally insert the hook on the valve end plate side into clamp B.
2. Press the valve body downward. (When the screw is released, it will be locked by clamp bracket A.)
3. Tighten the clamp screw. (Proper tightening torque: VQ1000, 0.25 to 0.35 N·m; VQ2000, 0.5 to 0.7 N·m.)

⚠ Caution

Dust on the sealing surface of the gasket or solenoid valve can cause air leakage.

Replacement of Cylinder Port Fittings

⚠ Caution

The cylinder port fittings are a cassette for easy replacement. The fittings are blocked by a clip. Take out the clip with a flat head screwdriver, etc., then replace the fittings.

For mounting, insert the fitting assembly until it strikes against the inside wall and then insert the clip to the specified position.

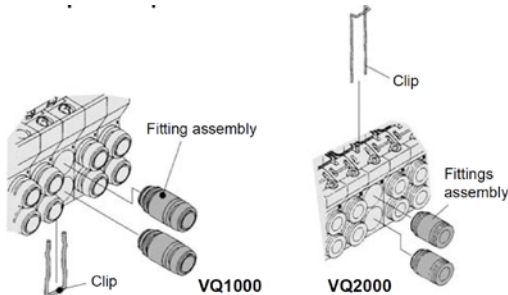

Applicable tubing O.D.	Fitting assembly part no.	
	VQ1000	VQ2000
Applicable tubing ø3.2	VVQ1000-50A-C3	—
Applicable tubing ø4	VVQ1000-50A-C4	VVQ1000-51A-C4
Applicable tubing ø6	VVQ1000-50A-C6	VVQ1000-51A-C6
Applicable tubing ø8	—	VVQ1000-51A-C8
M5	VVQ1000-50A-M5	—
Applicable tubing ø1/8"	VVQ1000-50A-N1	—
Applicable tubing ø5/32"	VVQ1000-50A-N3	VVQ1000-51A-N3
Applicable tubing ø1/4"	VVQ1000-50A-N7	VVQ1000-51A-N7
Applicable tubing ø5/16"	—	VVQ1000-51A-N9

* Refer to "Manifold Optional Parts" on pages 66, 67, 73 for other types of fittings.

⚠ Caution

1. Use caution that O-rings must be free from scratches and dust. Otherwise, air leakage may result.
2. After screwing in the fittings, mount the M5 fitting assembly on the manifold base. (Tightening torque: 0.8 to 1.2 N·m)
3. Purchasing order is available in units of 10 pieces.

How to Mount/Remove DIN Rail

⚠ Caution

Removing

1. Loosen the clamp screw on side (a) of the end plate on both sides.
2. Lift side (a) of the manifold base and slide the end plate in the direction of (2) shown in the figure to remove.

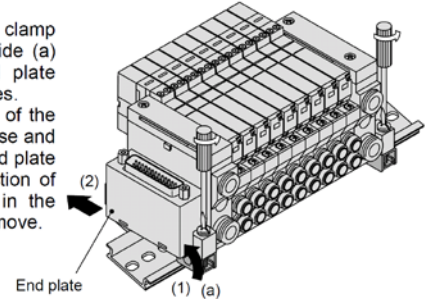

Mounting

1. Hook side (b) of the manifold base on the DIN rail.
2. Press down side (a) and mount the end plate on the DIN rail. Tighten the clamp screw on side (a) of the end plate. The proper tightening torque for screws is 0.4 to 0.6 N·m.

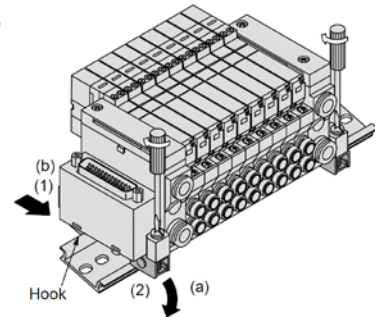

IP65 Enclosure

⚠ Caution

Wiring connection for models conforming to IP65 should also have enclosures equivalent to or of stricter than IP65.

Built-in Silencer Element

⚠ Caution

A filter element is incorporated in the end plate on both sides of the manifold base. A dirty and choked element may reduce cylinder speed or cause malfunction. Clean or replace the dirty element.

Element Part No.

Type	Element part no.	
	VQ1000	VQ2000
Built-in silencer, direct exhaust	VVQ1000-82A-1	VVQ2000-82A-1

The minimum order quantity is 10 pcs.

Remove the cover from the top of the end plate and remove the old element with a flat head screwdriver, etc.

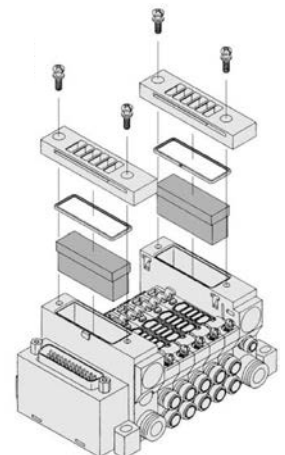

No. VQ1000V-OMM002-B



VQ1000/2000 series

Specific Product Precautions 3

Be sure to read this before handling

How to Calculate Flow Rate

$$\frac{P_2 + 0.1}{P_1 + 0.1} \leq 0.5, \text{ choked flow}$$

$$Q = 120 \times S (P_1 + 0.1) \sqrt{\frac{293}{273 + t}}$$

$$\frac{P_2 + 0.1}{P_1 + 0.1} > 0.5, \text{ subsonic flow}$$

$$Q = 240 \times S \sqrt{(P_2 + 0.1) (P_1 - P_2)} \sqrt{\frac{293}{273 + t}}$$

Conversion with sonic conductance C:

S=5.0XC

Q : Air flow rate [dm³/min(ANR)]

S : Effective area [mm²]

P₁ : Upstream pressure [MPa]

P₂ : Downstream pressure [MPa]

t : Temperature [°C]

Trouble	When the valve is failing, use this flow chart to clarify the cause of the failure and take countermeasures appropriate for the cause.	Possible cause	Countermeasures
<p>Operating failure The air supply does not switch the valve.</p>	<pre> graph TD Q1{Can manual override move the valve} -- NO --> C1 Q1 -- YES --> Q2{Does the indicator light keep turning on during energization?} Q2 -- NO --> C2 Q2 -- YES --> C3 </pre>	<p>1) Sliding failure or stick of main valve. A foreign material included in supplied air is caught by main valve and makes the main valve unable to slide smoothly or sticky.</p>	<ul style="list-style-type: none"> • Replace with new valve. • Clean the supplied air.
		<p>2) Pressure drop. The pressure of supplied air lowers the valve which can operate the valve (min. operating pressure).</p>	<p>Raise the pressure of supplied air up to operating pressure of the valve.</p>
		<p>1) Failure of electrical system</p> <ul style="list-style-type: none"> • Incorrect wiring • Blow of fuse and breakage of lead wire. • Poor contact at contactor wire or connection part • Failure of sequencer • Lack of supply voltage 	<p>Check these items and replace part and re-wire positively.</p>
		<p>1) Voltage drop Even if the indicator light keeps turning on, the valve can't be operated due to the voltage drop.</p>	<ul style="list-style-type: none"> • Check the voltage and if it is not enough to operate the valve, take appropriate measures.
		<p>2) Leakage current When the power turns off, the valve can't be switched due to residual voltage.</p>	<ul style="list-style-type: none"> • Confirm the residual voltage is follows. • DC is 3% or AC is 8% or less of rated voltage.
		<p>3) Failure of pilot valve</p> <ul style="list-style-type: none"> • Foreign matter caught in core of pilot valve. • Disconnection coil wire of pilot valve • Swelled out poppet of pilot valve • Burnt coil of pilot valve (Higher voltage or wrong coil used, Coil splashed by water) 	<ul style="list-style-type: none"> • Replace part or re-wire positively. • Check voltage. Replace valve. (Pilot valve) • Replace valve (pilot valve). Protect the valve so that water does not splash the coil.
<p>Response failure The operation of the valve is delay.</p>		<p>1) Current leakage When the power turns off, the valve can be switched late due to residual voltage.</p>	<ul style="list-style-type: none"> • Confirm the residual voltage is follows. • DC is 3% or AC is 8% or less of rated voltage.
		<p>2) Clogging of filter element of manifold.</p>	<ul style="list-style-type: none"> • Clean the element or replace with new element.
		<p>3) Sliding failure or stick of main valve. A foreign material included in supplied air is caught by main valve and makes the main valve unable to slide smoothly or sticky.</p>	<ul style="list-style-type: none"> • Replace with new valve. • Clean the supplied air.

Trouble	When the valve is failing, use this flow chart to clarify the cause of the failure and take countermeasures appropriate for the cause.	Possible cause	Countermeasures
Air leakage	<div style="border: 1px solid black; border-radius: 10px; padding: 5px; width: fit-content; margin: 0 auto;">Confirm there is air leakage.</div> <p>1. Between valve and base</p>	1-1) Looseness of clamp screw or mounting bolt.	Give more torque to clamp screw. •VQ1000 : 0.25~0.35N·m •VQ2000 : 0.5~0.7N·m If the damage is seen on the gasket, replace with new gasket.
		1-2) Caught gasket	Replace with new gasket.
		1-3) Intrusion of foreign matter	To remove foreign matter by air blow of piping and when a gasket damaged, replace with new gasket.
	2. Air leaks through One-touch fitting	2-1) Tube is not inserted enough deeply. 2-2) Tube has a flaw. 2-3) Tube is cut diagonally.	Check these items and replace part and re-wire positively.
		2-4) Packing of one touch fitting is damaged.	
	3. Air leaks through exhaust port (R port) Note) The valve with metal seal allows air leakage from main valve approx. 200Ncc for each port (at 0.5MPa). The air leakage within the range should not be considered abnormal.	3-1) Looseness of clamp screw or mounting bolt.	Give more torque to clamp screw. Tightening torque •VQ1000 : 0.25~0.35N·m •VQ2000 : 0.5~0.7N·m If the damage is seen on the gasket, replace with new gasket.
		3-2) A foreign material included into supplied air is caught by the main valve and increases internal air leakage.	
	4. Air leaks through manifold.	Insufficient bolt tightening	After stopping air and re-tighten the bolts.

Revision history

A	Safety Instructions	oY
B	How to calculate flow rate: Correction of errata	VZ

1st printing : MW

SMC Corporation

4-14-1, Sotokanda, Chiyoda-ku, Tokyo 101-0021 JAPAN
Tel: + 81 3 5207 8249 Fax: +81 3 5298 5362
URL <http://www.smcworld.com>

Note: Specifications are subject to change without prior notice and any obligation on the part of the manufacturer.
© 2008 SMC Corporation All Rights Reserved

