



# Operation Manual

Solenoid Valve

PRODUCT NAME

SYJ Series

MODEL/ Series

**SMC Corporation**

# Contents

Safety Instructions	2,3
Precautions on Design	4,5
Selection	4,5
Mounting	5
Piping	5,6
Wiring	6
Lubrication	6
Air Supply	6,7
Operating Environment	7
Maintenance	7
Specific Product Precautions	8 ~13
Trouble shooting	14,15



# Safety Instructions

These safety instructions are intended to prevent hazardous situations and/or equipment damage. These instructions indicate the level of potential hazard with the labels of “Caution,” “Warning” or “Danger.” They are all important notes for safety and must be followed in addition to International Standards (ISO/IEC)\*1), and other safety regulations.

- \*1) ISO 4414: Pneumatic fluid power -- General rules relating to systems
- ISO 4413: Hydraulic fluid power -- General rules relating to systems
- IEC 60204-1: Safety of machinery -- Electrical equipment of machines (Part 1: General requirements)
- ISO 10218-1992: Manipulating industrial robots -- Safety



## Caution

**Caution** indicates a hazard with a low level of risk which, if not avoided, could result in minor or moderate injury.



## Warning

**Warning** indicates a hazard with a medium level of risk which, if not avoided, could result in death or serious injury.



## Danger

**Danger** indicates a hazard with a high level of risk which, if not avoided, will result in death or serious injury.

## Warning

### **1. The compatibility of the product is the responsibility of the person who designs the equipment or decides its specifications.**

Since the product specified here is used under various operating conditions, its compatibility with specific equipment must be decided by the person who designs the equipment or decides its specifications based on necessary analysis and test results.

The expected performance and safety assurance of the equipment will be the responsibility of the person who has determined its compatibility with the product.

This person should also continuously review all specifications of the product referring to its latest catalog information, with a view to giving due consideration to any possibility of equipment failure when configuring the equipment.

### **2. Only personnel with appropriate training should operate machinery and equipment.**

The product specified here may become unsafe if handled incorrectly.

The assembly, operation and maintenance of machines or equipment including our products must be performed by an operator who is appropriately trained and experienced.

### **3. Do not service or attempt to remove product and machinery/equipment until safety is confirmed.**

1. The inspection and maintenance of machinery/equipment should only be performed after measures to prevent falling or runaway of the driven objects have been confirmed.

2. When the product is to be removed, confirm that the safety measures as mentioned above are implemented and the power from any appropriate source is cut, and read and understand the specific product precautions of all relevant products carefully.

3. Before machinery/equipment is restarted, take measures to prevent unexpected operation and malfunction.

### **4. Contact SMC beforehand and take special consideration of safety measures if the product is to be used in any of the following conditions.**

1. Conditions and environments outside of the given specifications, or use outdoors or in a place exposed to direct sunlight.

2. Installation on equipment in conjunction with atomic energy, railways, air navigation, space, shipping, vehicles, military, medical treatment, combustion and recreation, or equipment in contact with food and beverages, emergency stop circuits, clutch and brake circuits in press applications, safety equipment or other applications unsuitable for the standard specifications described in the product catalog.

3. An application which could have negative effects on people, property, or animals requiring special safety analysis.

4. Use in an interlock circuit, which requires the provision of double interlock for possible failure by using a mechanical protective function, and periodical checks to confirm proper operation.



# Safety Instructions

## Caution

**The product is provided for use in manufacturing industries.**

The product herein described is basically provided for peaceful use in manufacturing industries.

If considering using the product in other industries, consult SMC beforehand and exchange specifications or a contract if necessary.

If anything is unclear, contact your nearest sales branch.

## Limited warranty and Disclaimer/Compliance Requirements

The product used is subject to the following "Limited warranty and Disclaimer" and "Compliance Requirements".

Read and accept them before using the product.

### Limited warranty and Disclaimer

**1.The warranty period of the product is 1 year in service or 1.5 years after the product is delivered.\*2)**

**Also, the product may have specified durability, running distance or replacement parts. Please consult your nearest sales branch.**

**2.For any failure or damage reported within the warranty period which is clearly our responsibility, a replacement product or necessary parts will be provided.**

**This limited warranty applies only to our product independently, and not to any other damage incurred due to the failure of the product.**

**3.Prior to using SMC products, please read and understand the warranty terms and disclaimers noted in the specified catalog for the particular products.**

**\*2) Vacuum pads are excluded from this 1 year warranty.**

**A vacuum pad is a consumable part, so it is warranted for a year after it is delivered.**

**Also, even within the warranty period, the wear of a product due to the use of the vacuum pad or failure due to the deterioration of rubber material are not covered by the limited warranty.**

### Compliance Requirements

**1.The use of SMC products with production equipment for the manufacture of weapons of mass destruction (WMD) or any other weapon is strictly prohibited.**

**2.The exports of SMC products or technology from one country to another are governed by the relevant security laws and regulation of the countries involved in the transaction. Prior to the shipment of a SMC product to another country, assure that all local rules governing that export are known and followed.**



# Precautions for 3/5 Port Solenoid Valve ①

Be sure to read before handling. Refer to main text for detailed precautions on every series.

## Design / Selection

### ⚠ Warning

#### 1. Confirm the specification

Products represented in this instruction manual are designed only for use in compressed air systems (including vacuum).

#### 2. Actuator drive

When an actuator, such as a cylinder, is to be driven using a valve, take appropriate measures (cover installation or approach prohibition) to prevent potential danger caused by actuator operation.

#### 3. Intermediate stopping

For 3-position closed center type, it is difficult to make a piston stop at the required position accurately due to the compressibility of air. Furthermore, since valves and cylinders are not guaranteed for zero air leakage, it may not be possible to hold a stopped position for an extended period of time. Please contact SMC if it is necessary to hold a stopped position for an extended period of time.

#### 4. Effect of back pressure when using a manifold.

Use caution when valves are used on a manifold, because an actuator may malfunction due to back-pressure. For 3-position exhaust center valve or single acting cylinder, take appropriate measures to prevent the malfunction by using it with an individual EXH spacer assembly, a back pressure check valve or an individual exhaust manifold.

#### 5. Holding of pressure (including vacuum).

Since the valve are subject to air leakage, they cannot be used for applications such as holding pressure (including vacuum) in a pressure vessel.

#### 6. Not suitable for use as an emergency shut-off valve, etc.

The valves listed in this catalog are not designed for safety applications such as an emergency shutoff valve. If the valves are used for the mentioned applications, additional safety measures should be adopted.

#### 7. Release of residual pressure

For maintenance purposes install a system for releasing residual pressure. Especially in the case of 3-position closed center valve or double check valve type, ensure that the residual pressure between the valve and the cylinder is released.

#### 8. Operation in a vacuum condition

When a valve is used for switching a vacuum, take measures to install a suction filter or similar to prevent external dust or other foreign matter from entering inside the valve. In addition, at the time of vacuum adsorption, be sure to vacuum at all times. Failure to do so may result in foreign matter sticking to the adsorption pad, or air leakage causing the workpiece to drop.

#### 9. Regarding a vacuum switch valve and a vacuum release valve.

If a non-vacuum is installed in the middle of piping system having a vacuum, the vacuum condition will not be maintained. Use a valve designed for use under vacuum condition.

#### 10. Double solenoid type

When using the double solenoid type for the first time, actuators may travel in an unexpected direction depending on the switching position of the valve. Implement measures to prevent any danger from occurring when operation the actuator.

#### 11. Ventilation

Provide ventilation when using a valve in a confined area, such as in a closed control panel. For example, install a ventilation opening, etc. in order to prevent pressure from increasing inside of the confined area and to release the heat generated by the valve.

#### 12. Extended periods of continuous energization

· If a valve will be continuously energized for an extended period of time, the temperature of the valve will increase due to the heat generated by the coil. This will likely adversely affect the performance of the solenoid valve and any nearby peripheral equipment. Therefore, when it is continuously energized or the energized period per day is longer than the de-energized period use either: DC specification, power-saving type. In addition, it is possible to shorten the energized time by making a valve with an N.O. (normally open) specification.

· For applications such as mounting a valve on a control panel, incorporate measure to limit the heat radiation so that the temperature will be high when a 3 station manifold.

#### 13. Do not disassemble the product of make any modifications, including additional machining.

It may cause human injury and/or an accident..

### ⚠ Caution

#### 1. Momentary energization

If a double solenoid valve is operated with momentary energization, it should be energized for at least 0.1 second. However, depending on the condition of the secondary load, it should be energized until the cylinder reaches the stroke and position, since there is a possibility of malfunction.

#### 2. Leakage voltage

Take note that the leakage voltage will increase when a resistor is used in parallel with switching element or a C-R circuit (surge voltage suppressor) is used for protecting a switching device because of the passing leakage voltage through the C-R circuit.

The suppressor residual leakage voltage should be as follows.

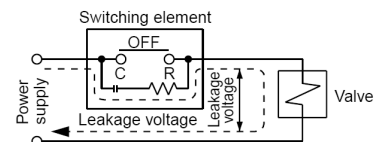

DC coil

Should be 3% or less of the rated voltage.

AC coil

Should be 8% or less of the rated voltage.



# Precautions for 3/5 Port Solenoid Valve ②

Be sure to read before handling. Refer to main text for detailed precautions on every series.

### 3. Solenoid valve drive for AC with solid state output (SSR, TRIAC output, etc.)

#### 1) Current leakage

When using a snubber circuit (C-R element) for surge protection of the output, a very small amount of electrical current will continue to flow even during the OFF state. This results in the valve not returning. In the a situation where the tolerance is exceeded, as in the above case, take measures to install a bleeder resistor.

#### 2) Minimum allowable load amount (Min. load current)

When the consumption current of a valve is less than the output's minimum allowable load volume or the margin is small, the output may not switch normally. Please contact SMC.

### 4. Surge voltage suppressor

If a surge protection circuit contains nonstandard diodes, such as Zener diodes or varistor, a residual voltage that is in proportion to the protective circuit and the rated voltage will remain. Therefore, take into consideration the surge voltage protection of the controller. In the case of diodes, the residual voltage is approximately 1 V.

### 5. Surge voltage intrusion

With non-polar type solenoid valves, at times of sudden interruption of the loading power supply, such as emergency shutdown, surge voltage intrusion may be generated from loading equipment with a large capacity (power consumption), and the solenoid valve in a de-energized state may switch over (see Figure 1). When installing a breaker circuit for the loading power supply, consider using a solenoid valve with polarity protection diode, or install a surge absorption diode between the larding equipment COM line and the output equipment COM line (see Figure 2).

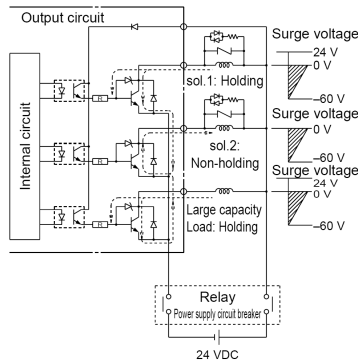

Figure 1. Surge intrusion circuit example (NPN outlet example)

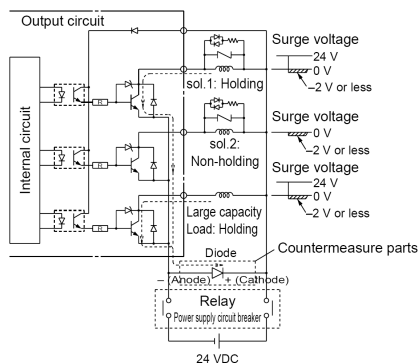

Figure 2. Surge intrusion circuit example (NPN outlet example)

### 6. Operation in a low temperature condition

It is possible to operated a valve in extreme temperature, as low as -10 °C. Take appropriate measures to avoid freezing of drainage, moisture etc. in low temperature.

### 7. Operation for air blowing

When using a solenoid valve for air blowing, use an external pilot type. Use caution because the pressure drop caused by the air blowing can have an affect on the internal pilot type valve and external pilot type valves are used on the same manifold.

Additionally, when compressed air within the pressure range of the established specifications is supplied to the external pilot type valve's port, and a double solenoid valve is used for air blowing, the solenoids should normally be energized when air is being blown.

### 8. Mounting orientation

Refer to the specifications of each series.

## Mounting

### Warning

#### 1. Operation manual

Install the products and operate them only after reading the operation manual carefully and understanding its contents. Also, keep the manual where it can be referred to as necessary.

#### 2. Ensure sufficient space for maintenance activities.

When installing the products, allow access for maintenance.

#### 3. Tighten threads with the proper tightening torque.

When installing the products, follow the listed torque specifications.

#### 4. If air leakage increases or equipment does not operated properly, stop operation.

Check mounting conditions when air and power supplies are connected. Initial function and leakage tests should be performed after installation.

#### 5. Painting and coating

Warnings or specifications printed or affixed to the product should not be erased, removed or covered up. Please consult with SMC before applying paint to resinous parts, as this may have an adverse effect due to the solvent in the paint.

## Piping

### Caution

#### 1. Refer to the Fittings and Tubing Precautions for handling one-touch fittings.

#### 2. Preparation before piping

Before piping is connected, it should be thoroughly blow out with air (flushing) or washed to remove chips, cutting oil and other debris from inside the pipe.

#### 3. Wrapping of pipe tape

When screwing piping or fittings into ports, ensure that chips from the pipe threads or sealing material do not enter the piping. Also, if pipe tape is used, leave 1 thread ridges exposed at the end of the threads.

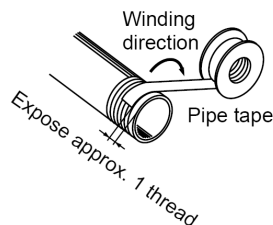



## SYJ Series

# Precautions for 3/5 Port Solenoid Valve ③

Be sure to read before handling. Refer to main text for detailed precautions on every series.

### 4. Closed center and double check valve types

For closed center type, check the piping to prevent air leakage from the piping between the valve and the cylinder.

### 5. Connection of fittings

When screwing fittings into valves, tighten as follows.

(1) Follow the procedures below when installing an SMC fitting, etc.

#### 1) M3 types

After tightening the fitting by hand, use a wrench to tighten the fitting an additional approximately 1/4 turn. As a reference value, tightening torque is 0.4 to 0.5N·m.

Note) If tightened excessively, the thread of the product may break or the gasket may deform. If tightened insufficiently, the thread of the product may become loose. In either case, air leakage can occur.

#### 2) M5 types

After tightening the fitting by hand, use a wrench to tighten the fitting a additional approximately 1/6 to 1/4 turn. As a reference value, tightening torque is 1 to 1.5 N·m.

(2) Follow the procedure of the manufacture when fittings other than SMC is used.

#### 2) Rc type

Tighten with the proper torque shown below.

#### Tightening Torque for Piping Applicable

Screwing piping	Reasonable tightening torque N·m
Rc1/8	7~ 9
Rc1/4	12~ 14

### 6. Piping to products

When piping to a product, refer to the instruction manual to avoid mistakes regarding the supply port, etc.

### Wiring

#### ⚠ Caution

##### 1. Polarity

When connecting power to a solenoid valve with a DC specification and equipped with a light or surge voltage suppressor, check for polarity. If there is polarity, take note of the following.

##### No diode to protect polarity.

If a mistake is made regarding the polarity, damage may occur to the diode in the valve, the switching element in a control device or power supply equipment, etc.

##### With diode to protect polarity.

If polarity connection is wrong, the valve does not operate.

##### 2. Applied voltage

When electric power is connected to a solenoid valve, be careful to apply the proper voltage. Improper voltage may cause malfunction or coil damage.

##### 3. Check the connections.

Check if the connections are correct after completing all wiring.

### Lubrication

#### ⚠ Caution

##### 1. Lubrication

1) The valve has been lubricated for life by the factory and does not require any further.

2) If a lubricant is used in the system, use class 1 turbine oil (no additive), ISO VG32.

Once a lubricant is used in the system, lubrication must be continued because the original lubricant applied during manufacturing will be washed away. If turbine oil is used, refer to the Material Safety Data Sheet (MSDS) of the oil.

3) Please contact SMC regarding class 2 turbine oil

### Air Supply

#### ⚠ Warning

##### 1. Type of fluids

Please consult with SMC when using the product in applications other than compressed air.

##### 2. When there is a large amount of drainage.

Compressed air containing a large amount of drainage can cause malfunction of pneumatic equipment. An air dryer or water separator should be installed upstream from filters.

##### 3. Drain flushing

If condensation in the drain bowl is not emptied on a regular basis, the bowl will overflow and allow the condensation to enter the compressed air lines. It causes malfunction of pneumatic equipment. If the drain bowl is difficult to check and remove, installation of a drain bowl with an auto drain option is recommended.

For compressed air quality, refer to SMC's Best Pneumatics catalog.

##### 4. Use clean air

Do not use compressed air that contains chemicals, synthetic oils including organic solvents, salt or corrosive gasses, etc., as it can cause damage or malfunction.

#### ⚠ Caution

**1. When extremely dry air is used as the fluid, degradation of the lubrication properties inside the equipment may occur, resulting in reduced reliability (or reduced service life) of the equipment. Please consult with SMC.**

##### 2. Install an air filter.

Install an air filter upstream near the valve. Select an air filter with a filtration size of 5 μm or smaller.

**3. Take measures to ensure air quality, such as by installing an aftercooler, air dryer, or water separator.**

Compressed air that contains a large amount of drainage can cause malfunction of pneumatic equipment such as valves. Therefore, take appropriate measures to ensure air quality, such as by providing an aftercooler, air dryer, or water separator.



## SYJ Series

# Precautions for 3/5 Port Solenoid Valve ④

Be sure to read before handling. Refer to main text for detailed precautions on every series.

### 4. If excessive carbon powder is seen, install a mist separator on the upstream side of the valve.

If excessive carbon dust is generated by the compressor, it may adhere to the inside of a valve and cause it to malfunction.

For compressed air quality, refer to SMC's Best Pneumatics catalog.

#### Operating Environment

### Warning

- Do not use in an atmosphere having corrosive gases, chemicals, sea water, water, water steam, or where there is direct contact with any of these .
- Products with IP65 enclosures (based on IEC60529) are protected against dust and water, however, these products cannot be used in water.
- Products compliant to IP65 satisfy the specifications through mounting. Be sure to read the Precautions for each product.
- Do not use in an environment where flammable gas or explosive gas exists. Usage may cause a fire or explosion. The products do not have an explosion proof construction.
- Do not use in a place subject to heavy vibration and/or shock.
- The valve should not be exposed to prolonged sunlight. Use a protective cover.
- Remove any sources of excessive heat.
- If it used in an environment where there is possible contact with oil, weld spatter, etc., exercise preventive measures.
- When the solenoid valve is mounted in a control panel or its energized for a long time, make sure ambient temperatures is within the specification of the valve.

#### Maintenance

### Warning

#### 1. Perform maintenance inspection according to the procedures indicated in the operation manual.

If handled improperly, malfunction and damage of machinery or equipment may occur.

#### 2. Removal of equipment, and supply/exhaust of compressed air

When components are removed, first confirm that measures are in place to prevent workpieces from dropping, run-away equipment, etc. Then, cut off the supply pressure and electric power, and exhaust all compressed air from the system using the residual pressure release function.

For 3-position closed center type, exhaust the residual pressure between the valve and the cylinder. When the equipment is operated after remounting or replacement, first confirm that measures are in place to prevent lurching of actuators, etc. Then, confirm that the equipment is operating normally.

#### 3. Low frequency operation

Valves should be operated at least once every 30 days to prevent malfunction. (Use caution regarding the air supply.)

#### 4. Manual override operation

When the manual override is operated, connected equipment will be actuated.

Operate after safety is confirmed.

### Caution

#### 1. Drain flushing

Remove drainage from the air filters regularly.

#### 2. Lubrication

In the case of rubber seals, once lubrication has been started, it must be continued.

Use class 1 turbine oil (with no additive), VG32 because if other lubricant oil is used, it may cause malfunction. Please contact SMC for suggested class 2 turbine oil class 2 (with additive), VG32.

#### How to Find the Flow Rate (at air temperature of 20 °C)

Subsonic flow when  $(P2+0.100)/(P1+0.100) > 0.5$

$$Q = 240S\sqrt{\Delta P(P1+0.100)}$$

Sonic flow when  $(P2+0.100)/(P1+0.100) \leq 0.5$

$$Q = 120S(P1+0.100)$$

Q: Air flow rate [dm<sup>3</sup>/min(ANR)]

S: Effective sectional area (mm<sup>2</sup>)

Δ P: Differential pressure P1- P2 [MPa]

P1: Upstream pressure [MPa]

P2: Downstream pressure [MPa]

※ Correction for different air temperatures

Multiply the flow rate calculated with the about formula by a coefficient from the table below.

Air temperature (°C)	-20	-10	0	10	30	40	50	60
Correction coefficient	1.08	1.06	1.04	1.02	0.98	0.97	0.95	0.94





# SYJ Series/Specific Product Precautions 1

Be sure to read this before handling

## Manual Override Operation

### Warning

When the manual override is operated, connected equipment will be actuated. Confirm safety before operating.

#### ■Non-locking push type [Standard]

Press in the direction of the arrow.

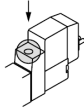

#### ■Push-turn slotted locking type [Type D]

While pressing, turn in the direction of the arrow. If it is not turned, it can be operated the same way as the non-locking type.

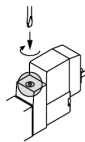

Locked position



### Caution

When operating the locking type D with a screw driver, turn it gently using a watchmakers' screwdriver. [Torque: Less than 0.1N·m]

#### ■Push-turn lever locking type [Type E]

While pressing, turn in the direction of the arrow. If it is not turned, it can be operated the same way as the non-locking type.

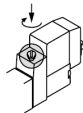

Locking position



### Caution

When locking the manual override on the push-turn locking types (D,E), be sure to push it down before turning. Turning without first pushing it down can cause damage to the manual override and trouble such as air leakage, etc.

### Solenoid valve for 200V,220V VAC specifications

### Warning

Solenoid valves with grommet and L/M type plug connector AC specification have a built-in rectifier circuit in the pilot section to operate the DC coil.

With 200V, 220V VAC specification pilot valves, this built-in rectifier generates heat when energized. The surface may become hot depending on the energized condition; therefore, do not touch the solenoid valves.

## Common Exhaust Type for Main and Pilot Valve

### Caution

Pilot air is exhausted through the main valve body rather than directly to atmosphere.

· Suitable for applications where exhausting the pilot valve to atmosphere would be detrimental to the surrounding working environment.

· For use in extremely dirty environments where there is the possibility that dust could enter the pilot exhaust and damage the valve.

Ensure that the piping of exhaust air is not too restrictive.

### Series SYJ3000/5000/7000 Mixed Installation of 3 Port and 5 Port Valves on Same Manifold.

### Caution

Series SYJ3000/5000/7000 and Series SYJ300/500/700 can be mounted on the same manifold. How to mount on the same manifold is shown on the following pages.

#### If 4 or 5 port valve is used as a 3 port valve

Series SYJ3000,5000,7000 may be used as a N.C. or N.O. 3 port valve by plugging one of the A,B ports. Be sure not to plug the exhaust ports (R). Can be used when a double solenoid, 3 port valve is required.

Plug position		B port	A port
Type of actuation		N.C.	N.O.
Number of solenoids	Single		
	Double		

## How to Use Plug Connector

### Caution

#### 1. Attaching and Detaching Connectors

· To attach a connector, hold the lever and connector unit between your fingers and insert straight onto the pins of the solenoid valve so that the lever's pawl is pushed into the groove and locks.

· To detach a connector, remove the pawl from the groove by pushing the lever downward with your thumb, and pull the connector straight out.

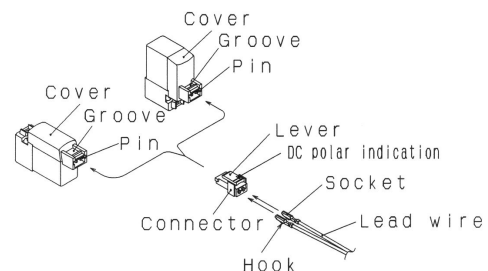



# SYJ Series/Specific Product Precautions 2

Be sure to read this before handling

## 2. Crimping of lead wires and sockets

Strip 3.2 to 3.7 mm at the end of the lead wires, insert the ends of the core wires evenly into the sockets, and then crimp with a crimping tool. When this is done, take care that the coverings of the lead wires do not enter the core wire crimping area. Use an exclusive crimping tool for crimping. (Please contact SMC for special crimping tools.)

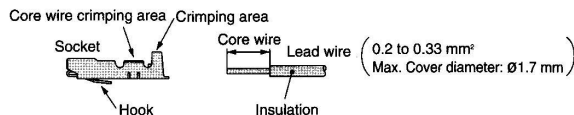

## 3. Attaching and detaching sockets with lead wires

### Attaching

Insert the sockets into the square holes of the connector (+,- indication), and continue to push the sockets all the way in until they lock by hooking into the seats in the connector, (When they are pushed in, their hooks open and they are locked automatically.) Then confirm that they are locked by pulling lightly on the lead wires.

### Detaching

To detach a socket from a connector, pull out the lead wire while pressing the socket's hook with a stick having a thin tip (approx. 1mm). If the socket will be used again, first spread the hook outward.

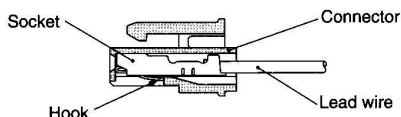

## Surge Voltage Suppressor



<For DC>

### Grommet, L /M plug connector Type

#### Standard type (with polarity)

Surge voltage suppressor (□S)

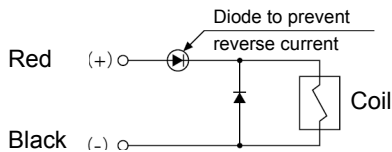

With light/surge voltage suppressor (□Z)

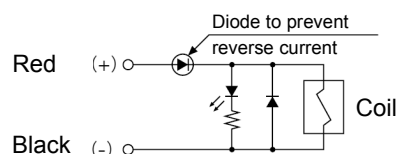

#### Non-polar type

With surge voltage suppressor (□R)

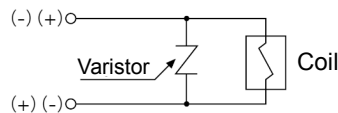

With light/surge voltage suppressor (□U)

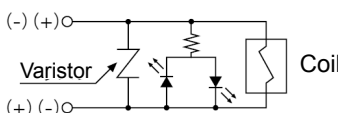

- Connect the standard type in accordance with the +,- polarity indication. (The non-polar type can be used with the connections made either way.)
- Since voltage specifications other than standard 24V and 12VDC do not have diodes for polarity protection, be careful not to make errors in the polarity.
- When wiring is done at the factory, positive (+) is red and negative (-) is black.

#### With power saving circuit

Power consumption is decreased by 1/4 by reducing the wattage required to hold the valve in an energized state. (Effective energizing time is over 62 ms at 24VDC.)

(In the case of SYJ<sup>3</sup>□□□T, the electric wave form of energy saving type)

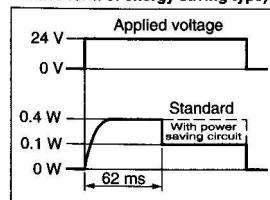

## DIN terminal Type

With surge voltage suppressor (DS)

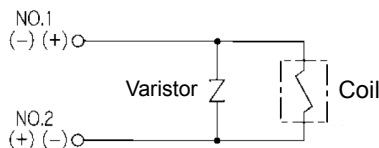

With light/surge voltage suppressor (□Z)

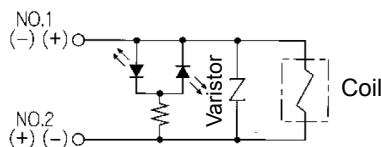

DIN terminal has no polarity.



# SYJ Series/Specific Product Precautions 3

Be sure to read this before handling

## M8 connector Type

### Standard type (with polarity)

With light/surge voltage suppressor (□S)

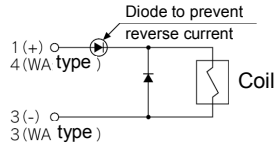

With light/surge voltage suppressor (□Z)

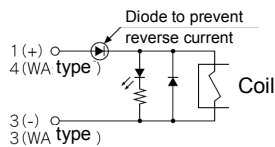

### Non-polar type

With surge voltage suppressor (□R)

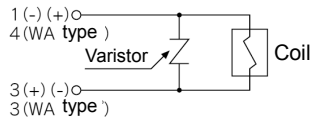

With light/surge voltage suppressor (□U)

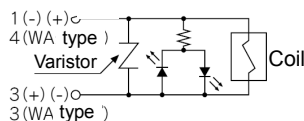

## Solenoid valve side pin wiring diagram

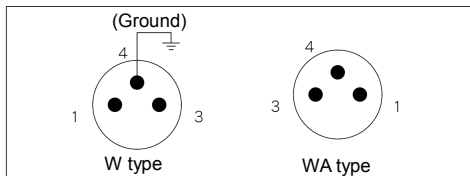

- In case of standard type (W type), connector + to 1 and – to 3 according the polarity. WA type connector + to 4 and – to 3 according the polarity.
- For DC voltages other than 12V and 24V, incorrect wiring will cause damage to the surge suppressor.
- The valve with the polarity protection diode be careful about the allowable voltage fluctuation since a voltage drop of about 1V.
- There is not ground to the valve of the WA type.

## <For AC>

(There is no “S” type because the generation of surge voltage is prevented by a rectifier.)

## Grommet, L/M plug Connector Type

With indicator light (□Z)

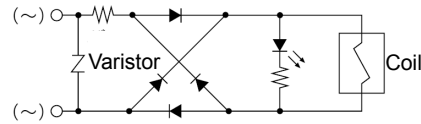

## DIN Terminal Type

With indicator light (DZ)

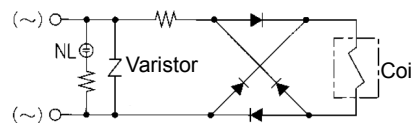

NL: Neon light

Note) Surge voltage suppressor of varistor has residual voltage corresponding to the protective element and rated voltage ; therefore, protect the controller side from the surge voltage. The residual voltage of the diode is approximately 1V.

## Y type DIN terminal

- Y type DIN connector conforming to DIN pitch 8mm standard.
- D type DIN connector with 9.4mm pitch between terminals if not interchangeable.
- To distinguish from the D type DIN connector, “N” is listed at the end of voltage symbol. (For connector parts without lights, “N” is not indicated. Please refer to the name plate to distinguish.)
- Dimension are completely the same as D type DIN connector.
- When exchanging the pilot valve assembly only. “V115-□D” is interchangeable with “V115-□Y”. Do not replace V114(G,H,L,M,W) to V115 (DIN terminal), and vice versa.



# SYJ Series/Specific Product Precautions 4

Be sure to read this before handling

## How to Use DIN Terminal

### Caution

#### Connection

1. Loosen the holding screw and pull the connector out of the solenoid valve terminal block.
2. After removing the holding screw, insert a flat head screwdriver, etc. into the notch on the bottom of the terminal block and pry it open, separating the terminal block and the housing.
3. Loosen the terminal screws (slotted screws) on the terminals block, insert the cores of the lead wires into the terminals according to the connection method, and fasten them securely with the terminal screws.
4. Secure the cord by fastening the ground nut.

### Caution

When making connections, take note that using other than the supported size ( $\varnothing 3.5$  to  $\varnothing 7$ ) heavy duty cord will not satisfy IP65 (enclosure) standards. Also, be sure to tighten the ground nut and holding screw within their specified torque ranges.

### Caution

#### Changing the entry direction

After separating the terminal block and housing, the cord entry can be changed by attaching the housing in the desired direction (4 directions at  $90^\circ$  intervals)

\*When equipped with a light, be careful not to damage the light with the cord's lead wires.

#### Precautions

Plug in and pull out the connector vertically without tilting to one side.

#### Compatible cable

Cord O.D.:  $\varnothing 3.5$  to  $\varnothing 7$

(Reference)  $0.5\text{mm}^2$ , 2-core or 3-core, equivalent to JIS C 3306

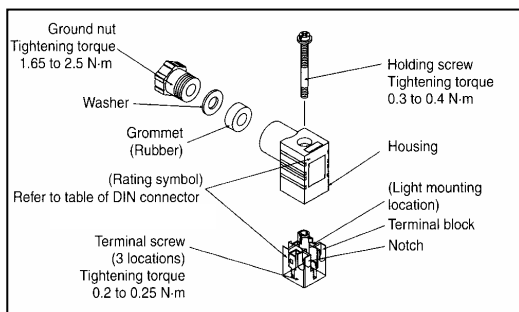

## Connector Assembly with Cover

### Caution

#### Connector assembly with dust proof protective cover

- Effective to prevention of short circuit failure due to the entry of foreign matter into the connector.
- Chloroprene rubber for electrical use, which provides outstanding weather resistance and electrical insulation, is used for the cover material. However, do not allow contact with cutting oil, etc.
- Simple and unencumbered appearance by adopting round-shaped cord.

## One-touch fittings

### Caution

- Tubing attachment/detachment for One-touch fittings

#### 1) Attaching of tubing

1. Take a tubing having no flaws on its periphery and cut it off at a right angle. When cutting the tubing, use tubing cutters TK-1,2 or 3. Do not use pinchers, nippers or scissors, etc. If cutting is done with tools other than tubing cutters, the tubing may be cut diagonally or become flattened, etc., making a secure installation impossible, and causing problems such as the tubing pulling out after installation or air leakage. Allow some extra length in the tubing.
2. Grasp the tubing and push it in slowly, inserting it securely all the way into the fitting.
3. After inserting the tubing, pull on it lightly to confirm that it will not come out. If it is not installed securely all the way into the fitting, this can cause problems such as air leakage or the tubing pulling out.

#### 2) Detaching of tubing

1. Push in the release button sufficiently, pushing its collar equally around the circumference.
2. Pull out the tubing while holding down the release button so that it does not come out. If the release button is not pressed down sufficiently, there will be increased bite on the tubing and it will become more difficult to pull it out.
3. When the removed tubing is to be used again, cut off the portion which has been chewed before reusing it. If the chewed portion of the tubing is used as is, this can cause trouble such as air leakage or difficulty in removing the tubing.



# SYJ Series/Specific Product Precautions 5

Be sure to read this before handling

## Other Tubing Brands

### Caution

1. When using other than SMC brand tubing, confirm that the following specifications are satisfied with respect to the outside diameter tolerance of the tubing.

- 1) Nylon tubing within  $\pm 0.1$ mm
- 2) Soft nylon tubing within  $\pm 0.1$ mm
- 3) Polyurethane tubing within  $\pm 0.1$ mm

Do not use tubing which do not meet these outside diameter tolerances. It may not be possible to connect them, or they may cause other trouble, such as air leakage or the tubing pulling out after connection.

## M8 connector

### Caution

- M8 connector types have an IP65 (enclosure) rating, offering protection from dust and water. However please note: these products are not intended for use in water. Select a SMC connector cable or a FA sensor type connector, with M8 threaded 3 pin specifications conforming to Nippon Electric Control Equipment Association Standard, NECA4202 (IEC60947-5-2). Make sure the connector O.D. is 10.5mm or less when used with the Series SYJ3000 manifold. If more than 10.5mm, it cannot be mounted due to the size.
- Do not use a tool to mount the connector, as this may cause damage. Only tighten by hand. (0.4 to 0.6 N·m)

### Caution

Failure to meet IP65 performance may result using alternative connectors than those shown above, or when insufficiently tightened.

## Connector cable mounting

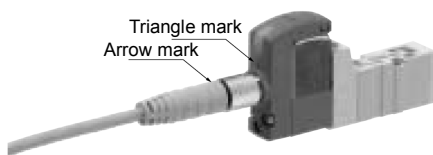

Note) Connector cable should be mounted in the correct direction. Make sure that the arrow symbol on the connector is facing the triangle symbol on the valve when using SMC connector cable. Be careful not to squeeze it in the wrong direction, as problems such as pin damage may occur.

## Bracket

### Caution

For bracket attached styles of SYJ3000 (Single) and SYJ7000, do not use it without bracket.

## Solenoid mounting

### Caution

Mount it so that there is no slippage or deformation in gasket, and tighten with the tightening torque as shown below.

Model	Thread size	Tightening torque
SYJ3000	M1.7	0.12N·m
SYJ5000	M2.5	0.45N·m
SYJ7000	M3	0.8N·m

## Replacement of Pilot Valve

### Caution

Pilot valve in this series are improved to provide excellent energy saving results. However following this improvement, these new valves are no longer compatible with the conventional pilot valve used at the interface. Please consult with SMC when you need to exchange these pilot valves, in the case of manual override (marked in orange) of the adapter plate.

### New type

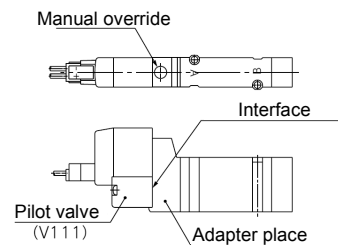

### Conventional type

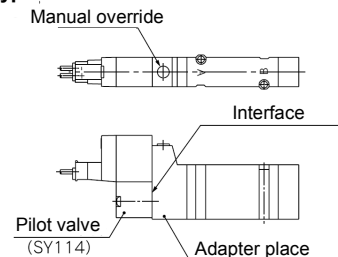



## SYJ Series/Specific Product Precautions 6

Be sure to read this before handling

### Interface Regulator

Spacer type regulation valve on manifold block can regulate the pressure to the valve individually.

#### Specification

Interface regulator		ARBYJ5000	ARBYJ7000
Applicable solenoid valve model		SYJ5000	SYJ7000
Regulating port		P	P
Proof pressure		1.5MPa	
Maximum operating pressure		1.5MPa	
Set pressure range		0.05 to 0.7 MPa <sup>Note 1)</sup>	
Ambient and fluid temperature		-5 to 60°C (No freezing) <sup>Note 2)</sup>	
Thread size for connection of pressure gauge		M5X0.8	
Weight (kg)		0.06	0.09
Effective area at exhaust side (mm <sup>2</sup> ) <small>Note 3)</small> S at P1=0.7MPa, P2=0.5MPa	P→A	1.9	5.1
	P→B	2.1	5.8
Effective area at supply side (mm <sup>2</sup> ) <small>Note 4)</small> S at P1=0.7MPa, P2=0.5MPa	A→EA	4.5	12.6
	B→EB	4.5	12.6

Note 1) Set the pressure within the operating pressure range of the solenoid valve.

Note 2) The maximum operating temperature for the solenoid valve is 50°C.

Note 3) The effective area listed is for a single solenoid 2 position valve mounted on a sub-plate.

Note 4) Apply pressure from P port in the base for interface regulator.

## TROUBLESHOOTING

Should any trouble be found during operation, trace the source of the trouble in the following order and take corrective acti

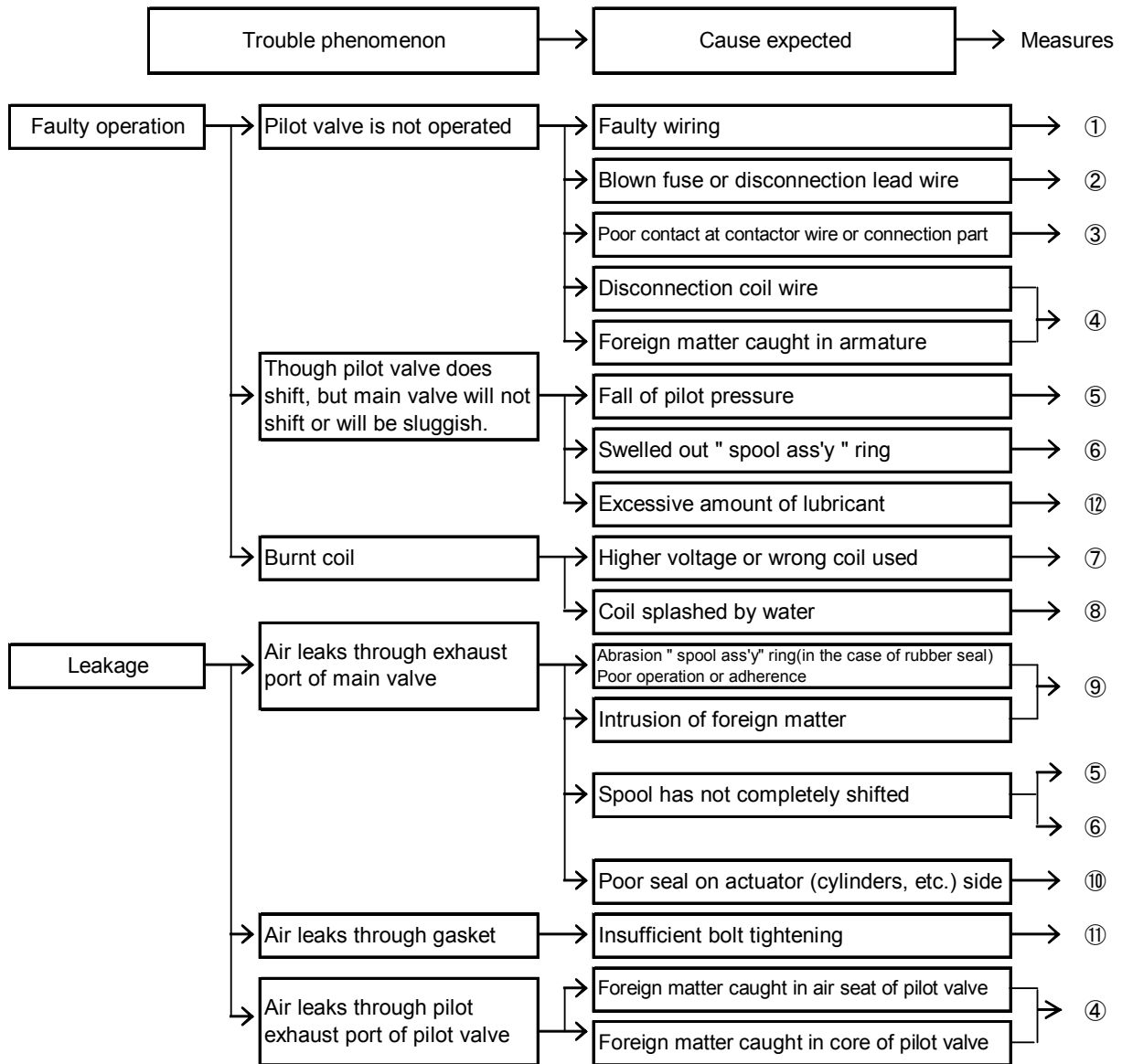

## Remedy

No.	Remedy
①	Re-wire correctly.
②	Replace part.
③	Replace part or re-wire positively.
④	Replace valve.
⑤	Regulate pressure so that pilot pressure will fall within operating pressure range during operation.
⑥	·If wrong oil is used, completely air blow to remove oil, and replace valve. After valve is replaced, use turbine oil class 1 (ISO VG32).
	·When a large quantity of drain is given and cannot carry out drain omission surely, install either an auto-drain or a dryer. The valve should be replaced.
⑦	Check voltage. Replace valve (pilot valve).
⑧	Protect the valve so that water does not splash the coil. Replace valve (pilot valve).
⑨	In case of intrusion of foreign matter, to remove foreign matter by air blow of piping and then replace valve.
⑩	Repair or replace actuators.
⑪	After stopping air and re-tighten the bolts.
⑫	Reduce the amount of lubricant to the degree that no oil splashes out of the air exhaust (R and PE) port.

If no improvement is achieved in spite of the above countermeasure, inside of the valve may have some abnormality. In this case, stop using the valve immediately.

If any of followings are carried out, inside of the valve may have some failure. In this case, stop using the valve immediately.

- ① Voltage out of rated voltage has been used.
- ② Oil other than the specified one has been lubricated.
- ③ Lubrication has been stopped intermediately, or lubrication was suspended temporary.
- ④ Water splashed directly.
- ⑤ Strong impact was given.
- ⑥ Alien substance such as drain and particle got into. Drain or garbage invaded a valve.
- ⑦ Prohibited way of using the valve which is written at "Precautions" section in this operation manual was carried out excluding above-mentioned.



Revision history

A Safety Instructions	oZ
-----------------------	----

1st Printing :MX

# SMC Corporation

4-14-1, Sotokanda, Chiyoda-ku, Tokyo 101-0021 JAPAN

Tel: + 81 3 5207 8249 Fax: +81 3 5298 5362

URL <http://www.smcworld.com>

---

Note: Specifications are subject to change without prior notice and any obligation on the part of the manufacturer.  
© 2008 SMC Corporation All Rights Reserved



No.SYJ3000-OMM0002-A