



Operation Manual

PRODUCT NAME

Electric Actuator / Low profile slider type

MODEL / Series / Product Number

LEM Series

Applicable models: LEMB, LEMC, LEMH, LEMHT

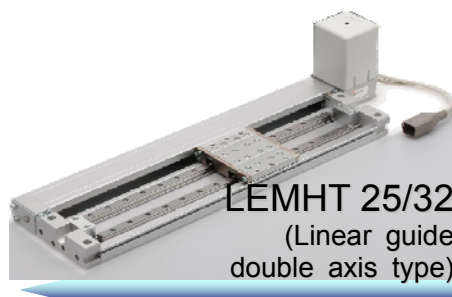

**<Controller>
LECP Series**

This manual describes the actuators operation in combination with the LECP6 series controllers. Refer to the manual relevant to the controller being used for full operating instructions.

SMC Corporation

Contents

Safety Instructions	2
1. Procedure before operation/simple setting to use straight away	4
1.1 Preparation.....	4
1.2 Controller setting software.....	5
1.3 Teaching box.....	7
2. Specification	9
2.1 Low profile slider type LEM Series.....	9
2.2 How to Order	12
2.3 Construction	14
3. Product Outline	17
3.1 System construction	17
3.2 Setting Function.....	18
3.3 Step data setting method.....	21
3.4 Parameter setting method.....	27
4. Wiring of cables / Common precautions	30
5. Electric actuators / Common precautions	31
5.1 Design and selection.....	31
5.2 Mounting.....	32
5.3 Handling.....	33
5.4 Operating environment	34
5.5 Maintenance	34
5.6 Precautions for actuator with lock	35
6. Electric actuators / Low profile slider type Common precautions	36
6.1 Design and selection.....	36
6.2 Handling.....	37
6.3 Mounting	38
6.4 Precaution on maintenance	41
7. Trouble shooting	43



LEM Series / Low profile slider type Safety Instructions

These safety instructions are intended to prevent hazardous situations and/or equipment damage. These instructions indicate the level of potential hazard with the labels of “Caution,” “Warning” or “Danger.” They are all important notes for safety and must be followed in addition to International Standards (ISO/IEC)^{*1)}, and other safety regulations.

*1) ISO 4414: Pneumatic fluid power -- General rules relating to systems.

ISO 4413: Hydraulic fluid power -- General rules relating to systems.

IEC 60204-1: Safety of machinery -- Electrical equipment of machines .(Part 1: General requirements)

ISO 10218-1992: Manipulating industrial robots -Safety.

etc.



Caution

Caution indicates a hazard with a low level of risk which, if not avoided, could result in minor or moderate injury.



Warning

Warning indicates a hazard with a medium level of risk which, if not avoided, could result in death or serious injury.



Danger

Danger indicates a hazard with a high level of risk which, if not avoided, will result in death or serious injury.

Warning

1. The compatibility of the product is the responsibility of the person who designs the equipment or decides its specifications.

Since the product specified here is used under various operating conditions, its compatibility with specific equipment must be decided by the person who designs the equipment or decides its specifications based on necessary analysis and test results.

The expected performance and safety assurance of the equipment will be the responsibility of the person who has determined its compatibility with the product.

This person should also continuously review all specifications of the product referring to its latest catalog information, with a view to giving due consideration to any possibility of equipment failure when configuring the equipment.

2. Only personnel with appropriate training should operate machinery and equipment.

The product specified here may become unsafe if handled incorrectly.

The assembly, operation and maintenance of machines or equipment including our products must be performed by an operator who is appropriately trained and experienced.

3. Do not service or attempt to remove product and machinery/equipment until safety is confirmed.

1. The inspection and maintenance of machinery/equipment should only be performed after measures to prevent falling or runaway of the driven objects have been confirmed.

2. When the product is to be removed, confirm that the safety measures as mentioned above are implemented and the power from any appropriate source is cut, and read and understand the specific product precautions of all relevant products carefully.

3. Before machinery/equipment is restarted, take measures to prevent unexpected operation and malfunction.

4. Contact SMC beforehand and take special consideration of safety measures if the product is to be used in any of the following conditions.

1. Conditions and environments outside of the given specifications, or use outdoors or in a place exposed to direct sunlight.

2. Installation on equipment in conjunction with atomic energy, railways, air navigation, space, shipping, vehicles, military, medical treatment, combustion and recreation, or equipment in contact with food and beverages, emergency stop circuits, clutch and brake circuits in press applications, safety equipment or other applications unsuitable for the standard specifications described in the product catalog.

3. An application which could have negative effects on people, property, or animals requiring special safety analysis.

4. Use in an interlock circuit, which requires the provision of double interlock for possible failure by using a mechanical protective function, and periodical checks to confirm proper operation.



Safety Instructions

Caution

1. The product is provided for use in manufacturing industries.

The product herein described is basically provided for peaceful use in manufacturing industries. If considering using the product in other industries, consult SMC beforehand and exchange specifications or a contract if necessary.
If anything is unclear, contact your nearest sales branch.

Limited warranty and Disclaimer/Compliance Requirements

The product used is subject to the following “Limited warranty and Disclaimer” and “Compliance Requirements”.

Read and accept them before using the product.

Limited warranty and Disclaimer

1. The warranty period of the product is 1 year in service or 1.5 years after the product is delivered, whichever is first.*2)

Also, the product may have specified durability, running distance or replacement parts. Please consult your nearest sales branch.

2. For any failure or damage reported within the warranty period which is clearly our responsibility, a replacement product or necessary parts will be provided.

This limited warranty applies only to our product independently, and not to any other damage incurred due to the failure of the product.

3. Prior to using SMC products, please read and understand the warranty terms and disclaimers noted in the specified catalog for the particular products.

***2) Vacuum pads are excluded from this 1 year warranty.**

A vacuum pad is a consumable part, so it is warranted for a year after it is delivered.

Also, even within the warranty period, the wear of a product due to the use of the vacuum pad or failure due to the deterioration of rubber material are not covered by the limited warranty.

Compliance Requirements

1. The use of SMC products with production equipment for the manufacture of weapons of mass destruction (WMD) or any other weapon is strictly prohibited.

2. The exports of SMC products or technology from one country to another are governed by the relevant security laws and regulations of the countries involved in the transaction. Prior to the shipment of a SMC product to another country, assure that all local rules governing that export are known and followed.

1. Procedure before operation/simple setting to use straight away

The controller is shipped with the parameters appropriate to the actuator.

With the simple setting “easy mode”, it can be operated and running parameters can be changed easily.

1.1 Preparation

(1) Items to be prepared

Please check on the label, and the quantity of accessories, to confirm that it is the product that was ordered.

Table 1. Components

No.	Part name	Qty
(1)	Electric actuator / Low profile slider type	1
(2)	Controller	1
(3)	Power supply plug	1
(4)	Actuator cable	1
(5)	I/O cable (Not use in this section)	1
(6)	Teaching box	1
(7)	Controller setting kit [The controller setting software, The communication cable, USB cable and conversion unit are included.]	1

(1) Electric actuator / Low profile slider type

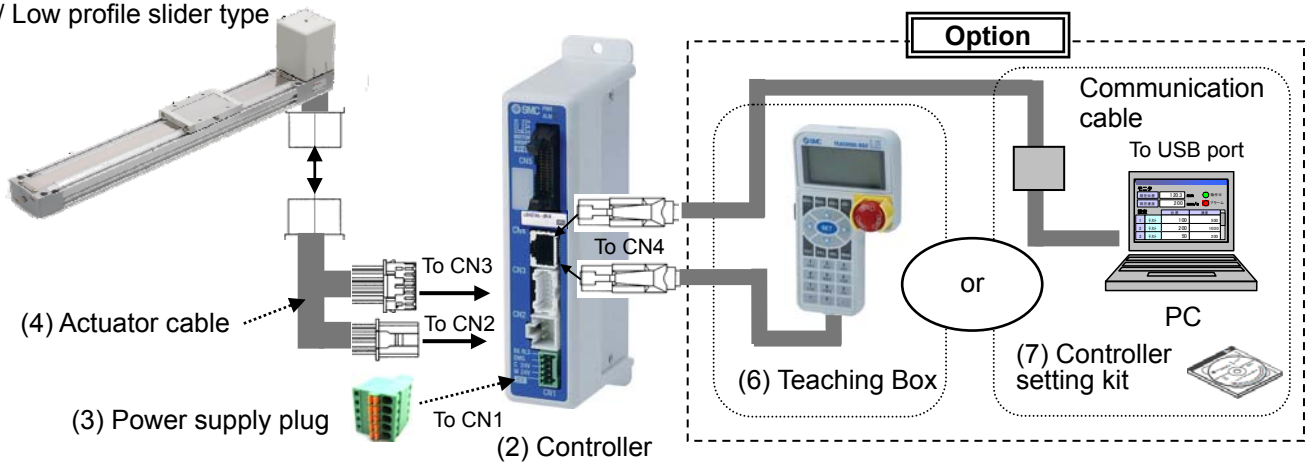

Table 2. Items to be prepared by the customer

Part name	Conditions
Power supply 24VDC Do not use the power supply with “Inrush-restraining type”	Refer to power consumption of each actuator/See 2.1 Specification on page 9 (Prepare the power supply that has capacity of “Moment max. power consumption” or more.)
Wire AWG20 (0.5mm ²)	Stripped wire length 8mm
Power supply plug Wiring	<p>Connect the plus side of 24VDC to the C24V, M24V and EMG terminals of the power supply plug, and the minus side to the 0V terminal. When conformity to UL is required, the electric actuator and controller should be used with a UL1310 Class 2 power supply.</p> <p><u>Step motor (servo 24VDC)</u></p> <p>Push the open/close lever and insert the wire into the electrical wire entry</p>

1.2 Controller setting software

1. Installation of software

With the controller setting software CD-ROM, install the communication unit software, following the "Software Installation procedure" (PDF)

2. Startup of software

After turning on the controller power supply start up the ACT Controller setting software

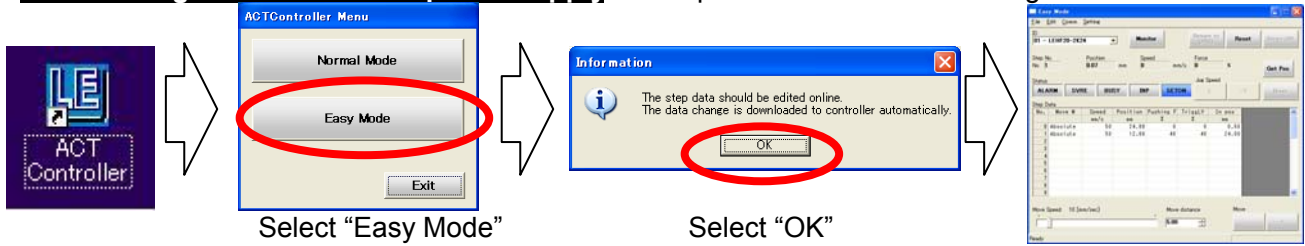

3. JOG Drive

a. Driving preparation: Servo On → Return to ORIG

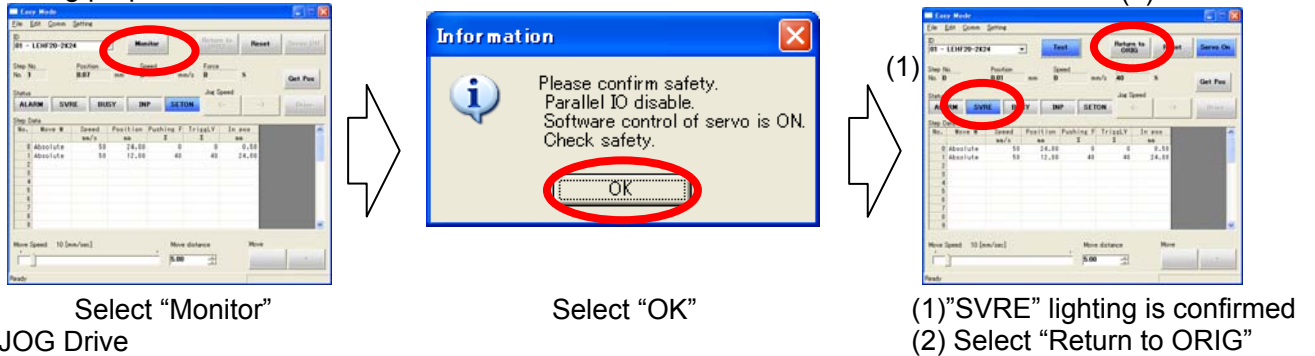

b. JOG Drive

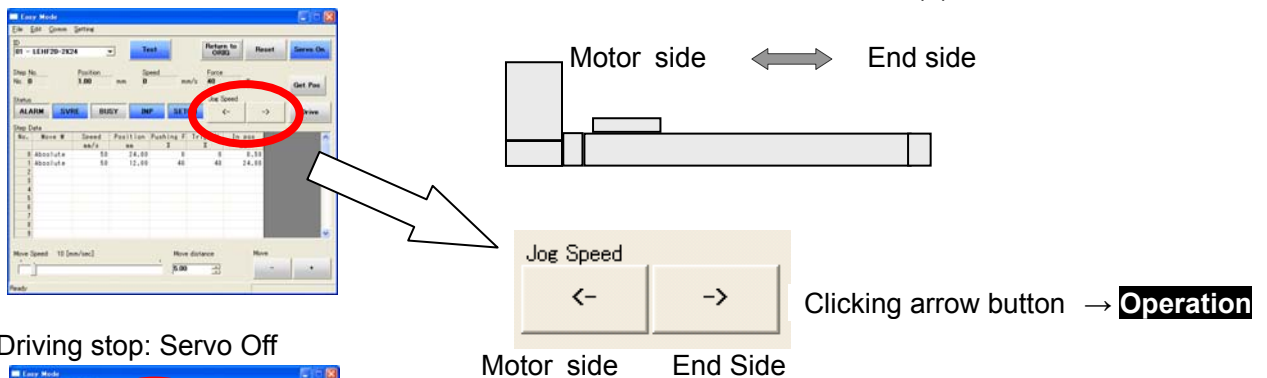

c. Driving stop: Servo Off

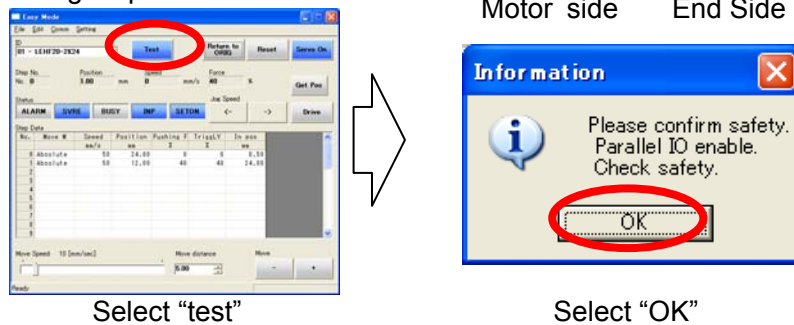

⚠ Caution

If an alarm is generated

When (1) "ALARM" is generated, release it by selecting (2) "Reset". In the case of an alarm code that cannot be released with "Reset", turn the power supply OFF and ON again.

(1)



Note) For details of alarm codes, refer to the Controller Operation Manual.

4. TEST Drive / Step No.0 → No.1 → No.0...

a. Driving preparation: Servo On → Return to ORIG / Refer to “3.JOG Drive”.

b. TEST Drive

“Step No.0” Operation

Procedure 1:
Select “Step No.0”
You can select anywhere in the row

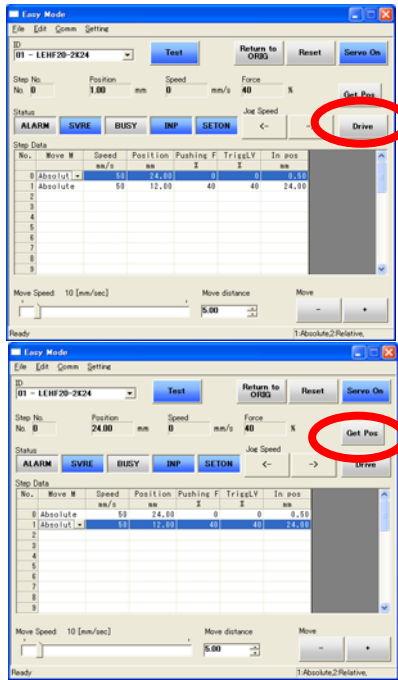

Procedure 2:
Select “Drive”

→ **Operation**

“Step No.1” Operation

Procedure 3:
Select “Step No.1”
You can select anywhere in the row



Procedure 4:
Select “Drive”

→ **Operation**

c. Driving stop : Servo Off / Refer to “3.JOG Drive”

5. Step data change

<“Step No.0” / Positioning operation> At the time of shipment, Step No.0 is set to positioning operation.

Step Data						
No.	Move M	Speed mm/s	Position mm	Pushing F %	TriggLV %	In posn mm
0	Absolute	500	100.00	0	0	1.00

Change of positioning stop position
Position: 100mm → 30mm

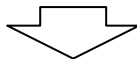

Input “30”

Step Data						
No.	Move M	Speed mm/s	Position mm	Pushing F %	TriggLV %	In posn mm
0	Absolute	500	30.00	0	0	1.00

For details of operation, and relationship between operation procedure and input/output signals, refer to “3.3 Step Data setting method” page 21 to 24.

6. Controller setting software screen explanation

Refer to the “Help / Easy mode” menu in the “ACT Controller” setting software.

1.3 Teaching box

1. Name

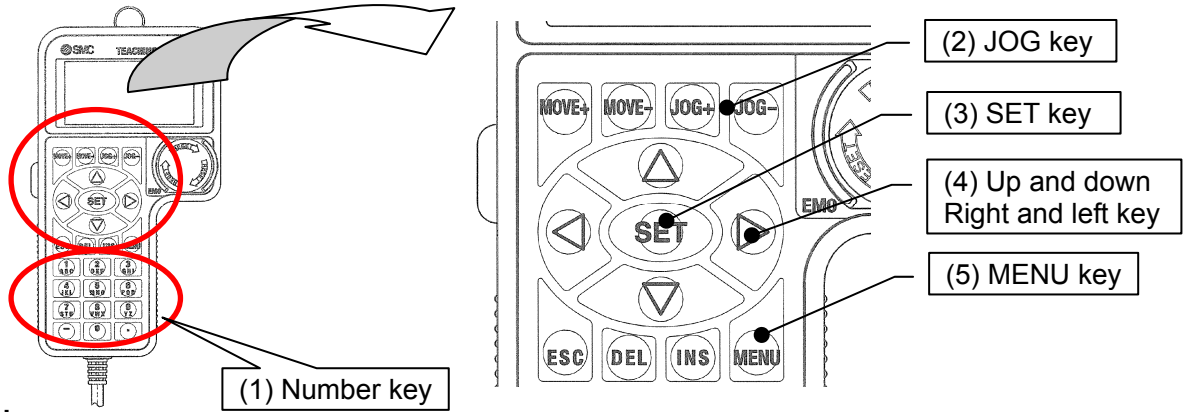

2. JOG Drive

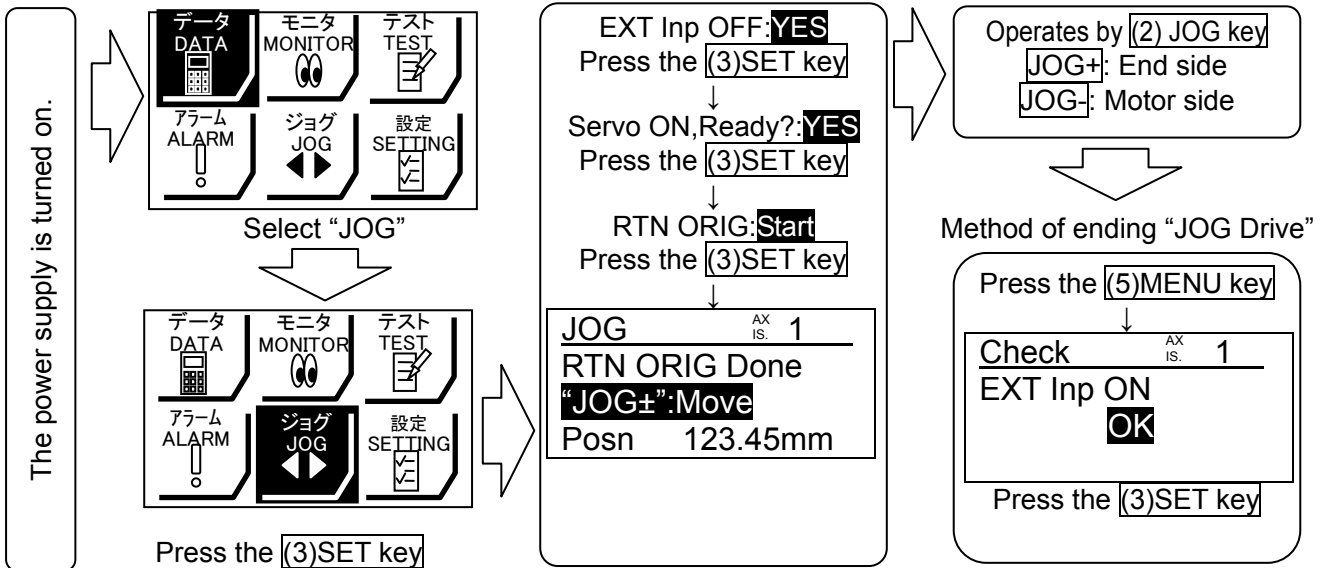

3. TEST Drive / Step No.0 → No.1 → No.0...

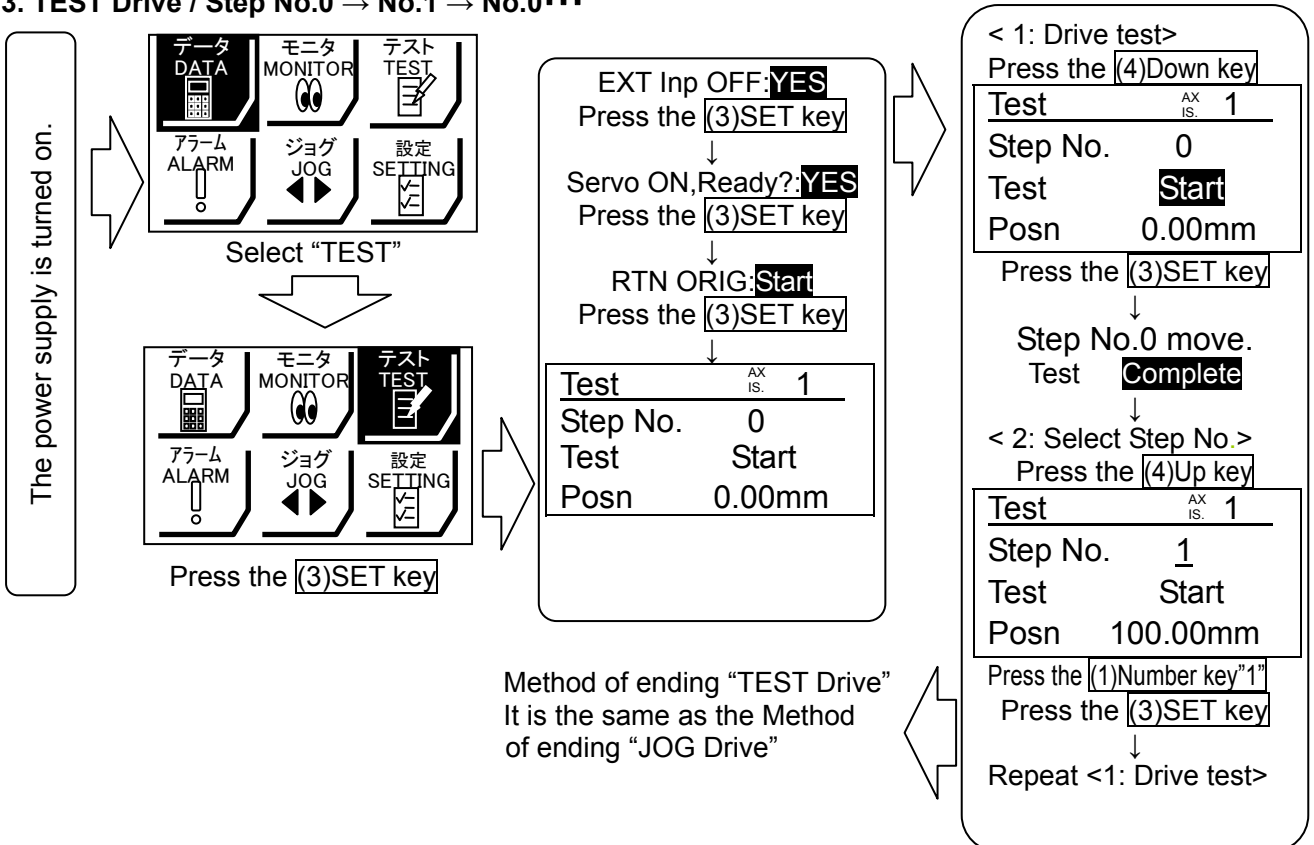

4. Step data change with positioning operation

<“Step No.0” / Positioning operation>

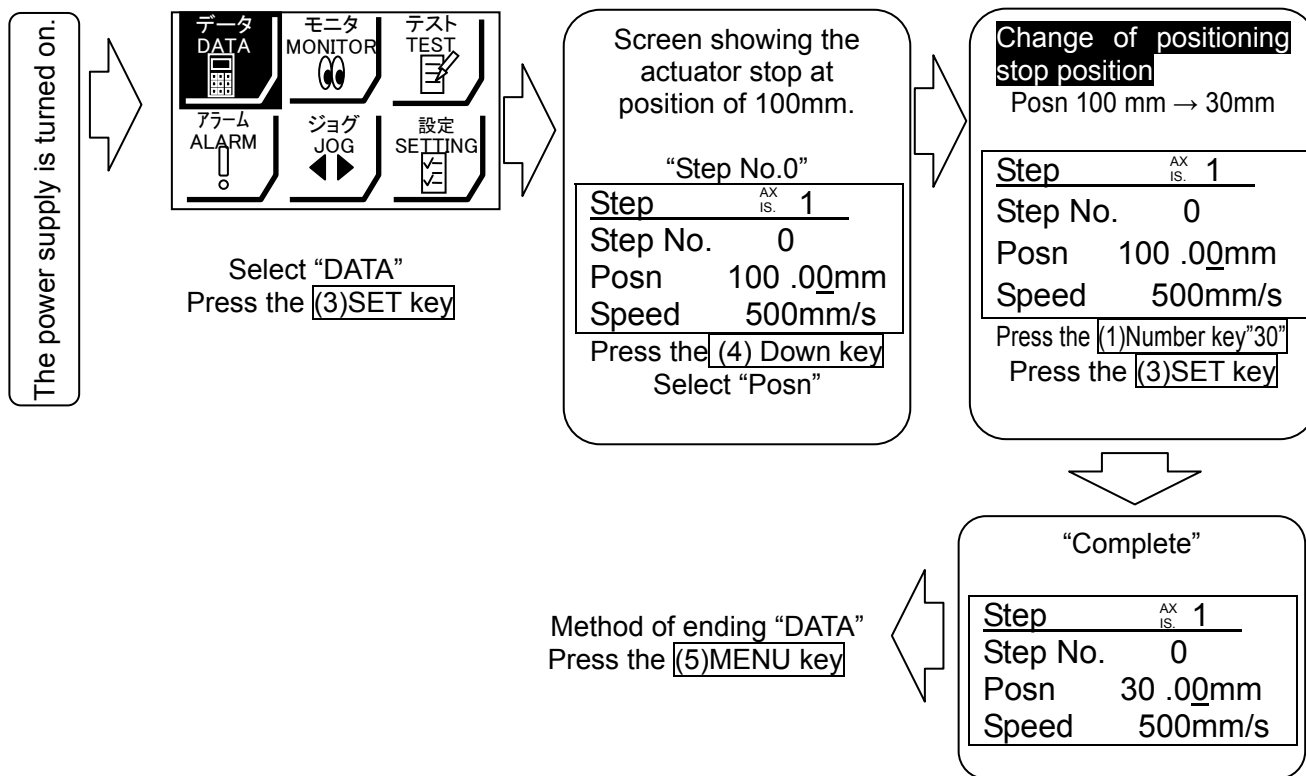

For details of operation, and relationship between operation procedure and input/ output signals, refer to section 3.3 "Step Data setting method" page 21 to 24.

5. Teaching box detailed explanation

Please refer to the teaching box manual.

2. Specification

2.1 Low profile slider type LEM Series

(1) LEMB (Basic type)

Model		LEMB25	LEMB32	
Actuator specification	Stroke (mm) ^{Note 1)}	100, 200, 300, 400, 500, 600, 700, 800, 900, 1000, (1100), 1200, (1300), (1400) 1500, (1600), (1700), (1800), (1900), 2000		
	Work load (kg) ^{Note 2)}	Horizontal	6(10)	11(20)
	Speed(mm/s)	48 to 1,000		
	Max. Acceleration/Deceleration (mm/s ²) ^{Note 9)}	20,000 (Depends on the workload)		
	Positioning repeatability (mm)	+/- 0.1		
	Lead equivalent (mm)	48		
	Drive method	Belt		
	Guide type	Slide bearing		
	Allowable external force (N) ^{Note 8)}	10		
	Operating temperature range (°C)	5 to 40	Operating temperature range (°C)	
	Operating humidity range (%RH)	90 or less (No condensation)		
Electric specification	Motor size	□56.4		
	Type of Motor	Step motor (Servo 24VDC)		
	Encoder	Incremental A/B phase (800 pulse/rotation)		
	Rated voltage (VDC)	24 +/- 10%		
	Power consumption (W) ^{Note 3)}	50	52	
	Standby power consumption when operating (W) ^{Note 4)}	44	44	
	Momentary max. power consumption (W) ^{Note 5)}	123	127	
Lock specification	Type ^{Note 6)}	No excitation operating type		
	Holding force (N)	36		
	Power consumption (W) ^{Note 7)}	5		
	Rated voltage (VDC)	24 +/- 10%		

Weight

Stroke(mm)	100	200	300	400	500	600	700	800	900	1000	1100	1200	1300	1400	1500	1600	1700	1800	1900	2000	
Weight (kg)	LEMB25	1.75	1.92	2.10	2.27	2.45	2.62	2.80	2.97	3.15	3.33	3.50	3.68	3.85	4.03	4.20	4.38	4.55	4.73	4.90	5.08
	LEMB32	2.11	2.29	2.47	2.64	2.82	3.00	3.17	3.35	3.53	3.70	3.88	4.06	4.23	4.41	4.59	4.76	4.94	5.12	5.29	5.47
Additional weight for lock (kg)	0.60																				

Note 1) The strokes shown in () are produced upon receipt of order. Consult with SMC as all non-standard and non-made-to-order strokes are produced as special orders.

There is the workload limitation when exceeding 1000mm strokes.

Note 2) The speed is dependent on the workload. Check the "Speed-workload graphs (Guide)" in the catalog for the selected model.

The workload is changed by the workload mounting condition. Check the "Allowable dynamic moment" graphs in the catalog for the selected model.

Also if the cable length exceeds 5m, the speed will be reduced 10% per 5m as the maximum.

The workload shown in () are when combined with another guide and the friction coefficient is 0.1 or less.

Note 3) The "Power consumption" (including the controller) is for when the actuator is operating.

Note 4) The "Standby power consumption when operating" (including the controller) is for when the actuator is stopped in the set position during operation.

Note 5) The "Momentary max. power consumption" (including the controller) is for when the actuator is operating.

This value can be used for the selection of the power supply.

Note 6) Only applies to actuators supplied with a lock.

Note 7) For the actuator with lock, please add the power consumption for the lock.

Note 8) The resistance value of the attached equipment should be within the allowable external resistance value.

Note 9) Maximum acceleration is limited by the workload and the stroke. Check the "Workload – acceleration graphs (Guide)" in the catalog for the selected model.

(2) LEMC (Cam follower guide type)

Model		LEMC25	LEMC32	
Actuator specification	Stroke (mm) ^{Note 1)}	100, 200, 300, 400, 500, 600, 700, 800, 900, 1000, (1100), 1200, (1300), (1400) 1500, (1600), (1700), (1800), (1900), 2000		
	Work load (kg) ^{Note 2)}	Horizontal	10	20
	Speed(mm/s)	48 to 1,000		
	Max. Acceleration/Deceleration (mm/s ²) ^{Note 9)}	20,000 (Depends on the workload)		
	Positioning repeatability (mm)	+/- 0.1		
	Lead equivalent (mm)	48		
	Drive method	Belt		
	Guide type	Cam follower guide		
	Allowable external force (N) ^{Note 8)}	10	20	
	Operating temperature range (°C)	5 to 40		
Operating humidity range (%RH)	90 or less (No condensation)			
Electric specification	Motor size	□56.4		
	Type of Motor	Step motor (Servo 24VDC)		
	Encoder	Incremental A/B phase (800 pulse/rotation)		
	Rated voltage (VDC)	24 +/- 10%		
	Power consumption (W) ^{Note 3)}	50	52	
	Standby power consumption when operating (W) ^{Note 4)}	44	44	
	Momentary max. power consumption (W) ^{Note 5)}	123	127	
Lock specification	Type ^{Note 6)}	No excitation operating type		
	Holding force (N)	36		
	Power consumption (W) ^{Note 7)}	5		
	Rated voltage (VDC)	24 +/- 10%		

Weight

Stroke(mm)		100	200	300	400	500	600	700	800	900	1000	1100	1200	1300	1400	1500	1600	1700	1800	1900	2000
Weight (kg)	LEMC25	2.18	2.46	2.74	3.01	3.29	3.57	3.85	4.12	4.40	4.68	4.95	5.23	5.51	5.79	6.06	6.34	6.62	6.90	7.17	7.45
	LEMC32	4.06	4.49	4.91	5.33	5.76	6.18	6.61	7.03	7.45	7.88	8.30	8.72	9.15	9.57	10.00	10.42	10.84	11.27	11.69	12.11
Additional weight for lock (kg)		0.60																			

Note 1) The strokes shown in () are produced upon receipt of order. Consult with SMC as all non-standard and non-made-to-order strokes are produced as special orders.

There is the workload limitation when exceeding 1000mm strokes.

Note 2) The speed is dependent on the workload. Check the "Speed-workload graphs (Guide)" in the catalog for the selected model.

The workload is changed by the workload mounting condition. Check the "Allowable dynamic moment" graphs in the catalog for the selected model.

Also if the cable length exceeds 5m, the speed will be reduced 10% per 5m as the maximum.

Note 3) The "Power consumption" (including the controller) is for when the actuator is operating.

Note 4) The "Standby power consumption when operating" (including the controller) is for when the actuator is stopped in the set position during operation.

Note 5) The "Momentary max. power consumption" (including the controller) is for when the actuator is operating.

This value can be used for the selection of the power supply.

Note 6) Only applies to actuators supplied with a lock.

Note 7) For the actuator with lock, please add the power consumption for the lock.

Note 8) The resistance value of the attached equipment should be within the allowable external resistance value.

Note 9) Maximum acceleration is limited by the workload and the stroke. Check the following "Workload – acceleration graphs (Guide)" in the catalog for the selected model.

(3) LEMH (Linear guide single axis type) / LEMHT (Linear guide double axis type)

Model		LEMH25/LEMHT25	LEMH32/LEMHT32
Actuator specification	Stroke (mm) ^{Note 1)}	100, 200, 300, 400, 500, 600, (700), (800), (900), (1000)	100, 200, 300, 400, 500, 600, (700), (800), (900), (1000), (1100), (1200), (1300), (1400) (1500)
	Work load (kg) ^{Note 2)}	Horizontal	10
	Speed(mm/s)	48 to 2,000	
	Max, Acceleration/Deceleration (mm/s ²) ^{Note 9)}	20,000 (Depends on the workload)	
	Positioning repeatability (mm)	+/- 0.1	
	Lead equivalent (mm)	48	
	Drive method	Belt	
	Guide type	Linear guide	
	Allowable external force (N) ^{Note 8)}	10	20
	Operating temperature range (°C)	5 to 40	
Operating humidity range (%RH)	90 or less (No condensation)		
Electric specification	Motor size	□56.4	
	Type of Motor	Step motor (Servo 24VDC)	
	Encoder	Incremental A/B phase (800 pulse/rotation)	
	Rated voltage (VDC)	24 +/- 10%	
	Power consumption (W) ^{Note 3)}	50	52
	Standby power consumption when operating (W) ^{Note 4)}	44	44
Momentary max. power consumption (W) ^{Note 5)}	123	127	
Lock specification	Type ^{Note 6)}	No excitation operating type	
	Holding force (N)	36	
	Power consumption (W) ^{Note 7)}	5	
	Rated voltage (VDC)	24 +/- 10%	

Weight

Stroke(mm)	100	200	300	400	500	600	(700)	(800)	(900)	(1000)	(1100)	1200	(1300)	(1400)	(1500)
Weight (kg)	LEMH25	2.05	2.32	2.59	2.87	3.14	3.42	3.69	3.96	4.24	4.51	-	-	-	-
	LEMH32	3.70	4.17	4.63	5.10	5.57	6.03	6.50	6.97	7.44	7.90	8.37	8.84	9.30	9.77
Additional weight for lock (kg)	0.60														

Weight

Stroke(mm)	100	200	300	400	500	600	(700)	(800)	(900)	(1000)	(1100)	1200	(1300)	(1400)	(1500)
Weight (kg)	LEMHT25	2.61	3.03	3.45	3.87	4.29	4.71	5.13	5.55	5.97	6.38	-	-	-	-
	LEMHT32	5.20	5.97	6.73	7.50	8.27	9.04	9.80	10.57	11.34	12.10	12.87	13.64	14.41	15.17
Additional weight for lock (kg)	0.60														

Note 1) The strokes shown in () are produced upon receipt of order. Consult with SMC as all non-standard and non-made-to-order strokes are produced as special orders.

There is the workload limitation when exceeding 1000mm strokes.

Note 2) The speed is dependent on the workload. Check the "Speed-workload graphs (Guide)" in the catalog for the selected model.

The workload is changed by the workload mounting condition. Check the "Allowable dynamic moment" graphs in the catalog for the selected model.

Also if the cable length exceeds 5m, the speed will be reduced 10% per 5m as the maximum.

Note 3) The "Power consumption" (including the controller) is for when the actuator is operating.

Note 4) The "Standby power consumption when operating" (including the controller) is for when the actuator is stopped in the set position during operation.

Note 5) The "Momentary max. power consumption" (including the controller) is for when the actuator is operating.

This value can be used for the selection of the power supply.

Note 6) Only applies to actuators supplied with a lock.

Note 7) For the actuator with lock, please add the power consumption for the lock.

Note 8) The resistance value of the attached equipment should be within the allowable external resistance value.

Note 9) Maximum acceleration is limited by the workload and the stroke. Check the "Workload – acceleration graphs (Guide)" in the catalog for the selected model.

2.2 How to Order

(1) LEMB (Basic type)

LEMB (Basic type) LEMB 25 □ T - 300 □ □ - S 1 2N 1 □

①
②
③
④
⑤
⑥
⑦
⑧
⑨
⑩
⑪

① Size

25
32

② Motor mounting position

Nil	Top mounting
U	Bottom mounting

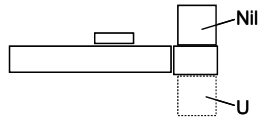

⑦ Actuator cable type

Nil	Without cable
S	Standard cable ^{Note}
R	Robotic cable (Flexible cable)

Note: Standard cable should be used on fixed parts.
For using on moving parts, select the robotic cable.

⑨ Controller type

Nil	Without controller	
6N	LECP6(Step data input type)	NPN
6P		PNP
2N	LECP2 (Program-less type)	NPN
2P		PNP
1N	LECP1 (Program-less type)	NPN
1P		PNP

③ Equivalent lead

T	48mm
---	------

⑤ Motor option

Nil	Without option
B	With lock

⑥ Stroke adjustment unit

Nil	Without unit
M	Motor side only
E	End side only
W	Both side

⑧ Actuator cable length

Nil	Without cable	8	8m ^{Note}
1	1.5m	A	10m ^{Note}
3	3m	B	15m ^{Note}
5	5m	C	20m ^{Note}

Note: Produced upon receipt of order (Robotic cable only).

⑩ I / O cable length

Nil	Without cable
1	1.5m
3	3m
5	5m

⑪ Controller mounting

Nil	Screw mounting
D	DIN rail mounting ^{Note}

Note: DIN rail is not included. Order it separately.

④ Stroke

	100	200	300	400	500	600	700	800	900	1000	1100	1200	1300	1400	1500	1600	1700	1800	1900	2000	
LEMB25	●	●	●	●	●	●	●	●	●	●	○	●	○	○	●	○	○	○	○	○	●
LEMB32	●	●	●	●	●	●	●	●	●	●	○	○	○	○	○	○	○	○	○	○	○

● Standard ○ Produced upon receipt of order

Note: Consult with SMC as all non-standard and non-made-to-order strokes are produced as special orders.
There is the workload limitation when exceeding 1000mm strokes.

(2) LEMC (Cam follower guide type)

LEMC (Cam follower guide type) LEMC 25 □ T - 300 □ - S 1 2N 1 □

①
②
③
④
⑤
⑥
⑦
⑧
⑨
⑩

① Size

25
32

② Motor mounting position

Nil	Top mounting
U	Bottom mounting
L	Symmetric, Top mounting
LU	Symmetric, Bottom mounting

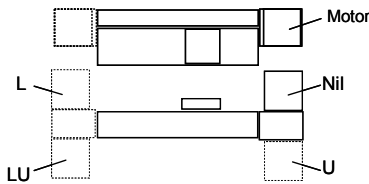

⑥ Actuator cable type

Nil	Without cable
S	Standard cable ^{Note}
R	Robotic cable (Flexible cable)

Note: Standard cable should be used on fixed parts.
For using on moving parts, select the robotic cable.

⑧ Controller type

Nil	Without controller	
6N	LECP6(Step data input type)	NPN
6P		PNP
2N	LECP2 (Program-less type)	NPN
2P		PNP
1N	LECP1 (Program-less type)	NPN
1P		PNP

⑦ Actuator cable length

Nil	Without cable	8	8m ^{Note}
1	1.5m	A	10m ^{Note}
3	3m	B	15m ^{Note}
5	5m	C	20m ^{Note}

Note: Produced upon receipt of order (Robotic cable only).

⑨ I / O cable length

Nil	Without cable
1	1.5m
3	3m
5	5m

⑩ Controller mounting

Nil	Screw mounting
D	DIN rail mounting ^{Note}

Note: DIN rail is not included. Order it separately.

④ Stroke

	100	200	300	400	500	600	700	800	900	1000	1100	1200	1300	1400	1500	1600	1700	1800	1900	2000	
LEMC25	●	●	●	●	●	●	●	●	●	●	○	●	○	○	●	○	○	○	○	○	●
LEMC32	●	●	●	●	●	●	●	●	●	●	○	○	○	○	○	○	○	○	○	○	○

● Standard ○ Produced upon receipt of order

Note: Consult with SMC as all non-standard and non-made-to-order strokes are produced as special orders.
There is the workload limitation when exceeding 1000mm strokes.

(3) LEMH (Linear guide single axis type) / LEMHT (Linear guide double axis type)

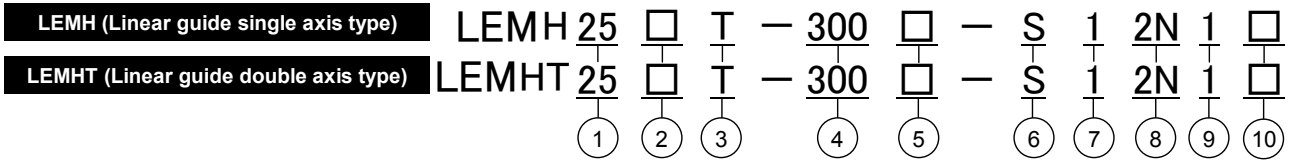

① Size

25
32

② Motor mounting position

Nil	Top mounting
U	Bottom mounting
L	Symmetric, Top mounting
LU	Symmetric, Bottom mounting

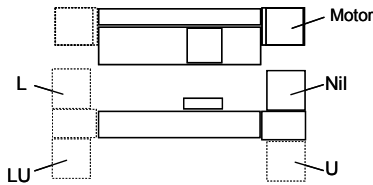

⑥ Actuator cable type

Nil	Without cable
S	Standard cable ^{Note}
R	Robotic cable (Flexible cable)

Note: Standard cable should be used on fixed parts.
For using on moving parts, select the robotic cable.

⑦ Actuator cable length

Nil	Without cable	8	8m ^{Note}
1	1.5m	A	10m ^{Note}
3	3m	B	15m ^{Note}
5	5m	C	20m ^{Note}

Note: Produced upon receipt of order (Robotic cable only).

⑧ Controller type

Nil	Without controller	
6N	LECP6 (Step data input type)	NPN
6P		PNP
2N	LECP2 (Program-less type)	NPN
2P		PNP
1N	LECP1 (Program-less type)	NPN
1P		PNP

③ Equivalent lead

T	48mm
---	------

⑤ Motor option

Nil	Without option
B	With lock

⑨ I/O cable length

Nil	Without cable
1	1.5m
3	3m
5	5m

⑩ Controller mounting

Nil	Screw mounting
D	DIN rail mounting ^{Note}

Note: DIN rail is not included. Order it separately.

④ Stroke

		100	200	300	400	500	600	700	800	900	1000	1100	1200	1300	1400	1500
LEMH25 / LEMHT25	●	●	●	●	●	●	●	○	○	○	○	○	○	○	○	○
LEMH32 / LEMHT32	●	●	●	●	●	●	●	○	○	○	○	○	○	○	○	○

● Standard ○ Produced upon receipt of order

Note: Consult with SMC as all non-standard and non-made-to-order strokes are produced as special orders.
There is the workload limitation when exceeding 1000mm strokes.

⚠ Caution

The actuator body and controller are sold as a package.

If when only the actuator is purchased separately, confirm that the combination of the controller, which you have and the actuator is compatible. / page33 Notes5.3 ⚠ Caution(1)

<Be sure to check the following before use.>

- (1) Check that actuator label for model number. This matches the controller.
- (2) Check Parallel I/O configuration matches (NPN or PNP).

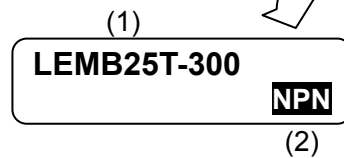

2.3 Construction

(1) LEMB

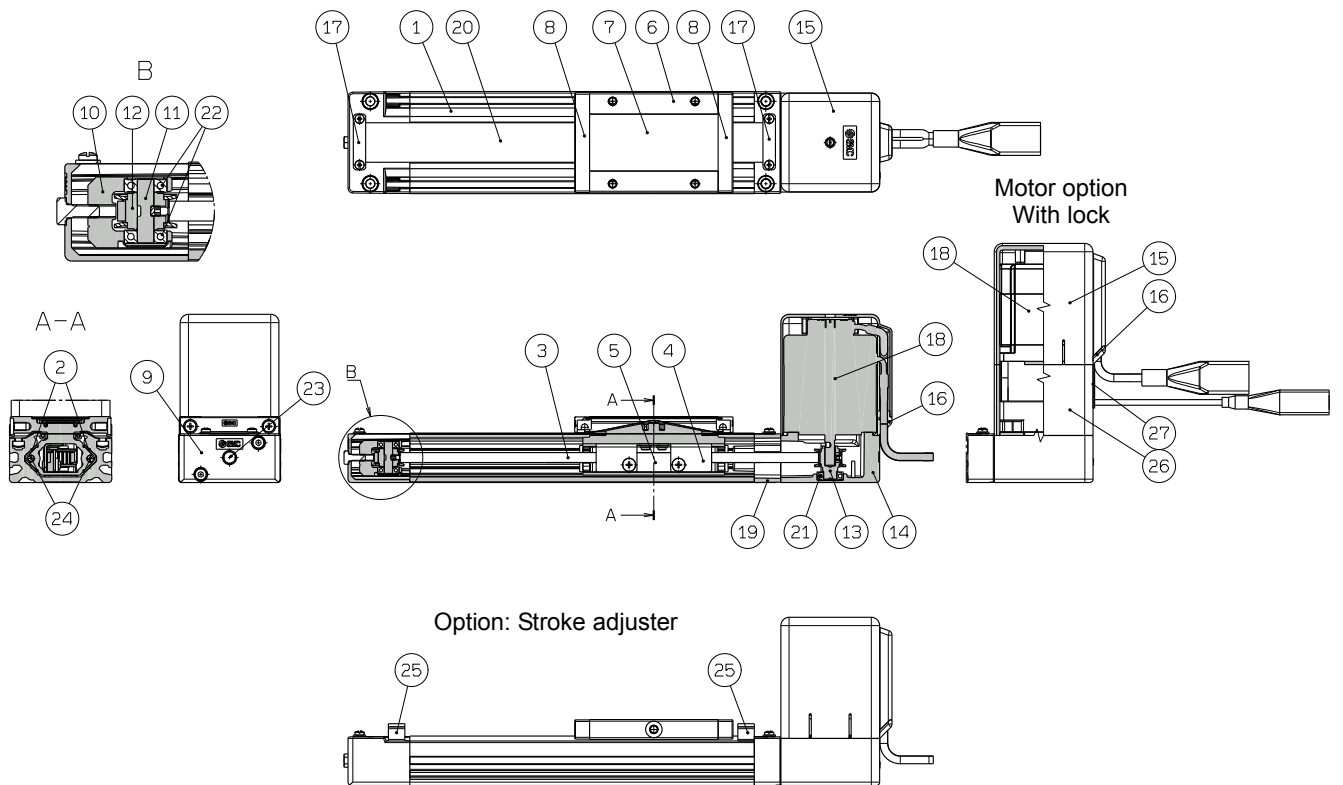

No.	Description	Material	Note
1	Body	Aluminum alloy	Anodized
2	Guide plate	Synthetic resin	
3	Belt	-	
4	Belt holder	Carbon steel	Chromating
5	Belt stopper	Aluminum alloy	
6	Table	Aluminum alloy	Anodized
7	Blanking plate	Aluminum alloy	Anodized
8	Seal band stopper	Synthetic resin	
9	End brock	Aluminum die-cast	Painting
10	Pulley holder	Aluminum alloy	
11	Pulley shaft	Stainless steel	Heat treatment + special treatment
12	End pulley	Aluminum alloy	Anodized
13	Motor pulley	Aluminum alloy	Anodized
14	Motor mount	Aluminum die-cast	Painting
15	Motor cover	Synthetic resin	

No.	Description	Material	Note
16	Grommet	Synthetic resin	
17	Band stopper	Stainless steel	
18	Motor	-	
19	Motor end brock	Aluminum die-cast	Painting
20	Dust seal band	Stainless steel	
21	Bearing	-	
22	Bearing	-	
23	Hexagon bolt	Carbon steel	Chromating
24	Magnet	-	
25	Stroke adjuster	Aluminum alloy	Anodized (Optional)
26	Motor cover for lock	Aluminum alloy	Anodized Only "with lock"
27	Grommet	CR	Chloroprene rubber Only "with lock"

(2) LEMC

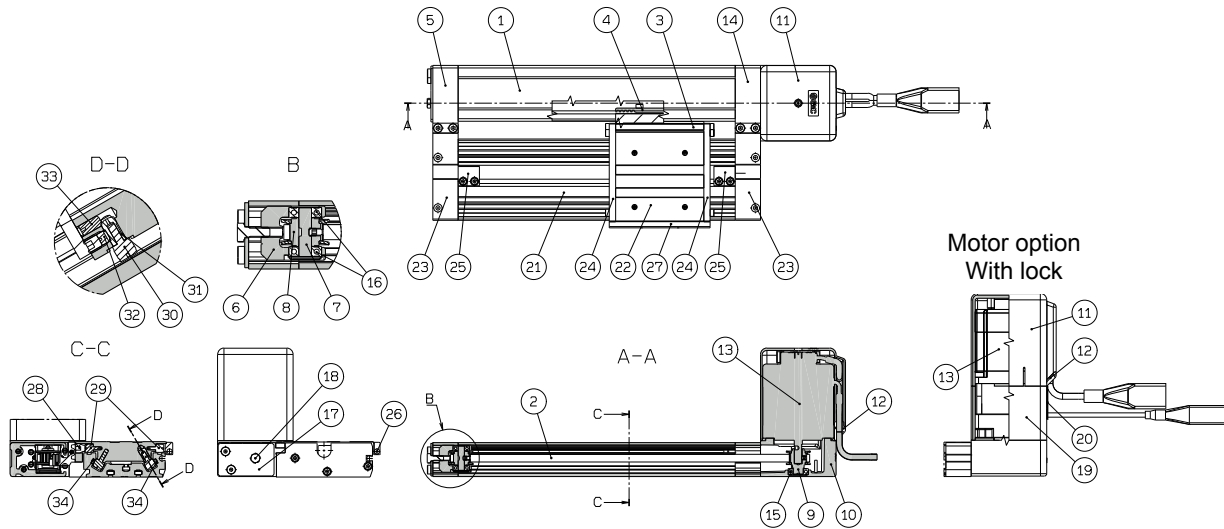

No.	Description	Material	Note
1	Body	Aluminum alloy	Anodized
2	Belt	-	
3	L shaped bracket	Aluminum alloy	Anodized
4	Belt stopper	Aluminum alloy	
5	End brock	Aluminum alloy	Anodized
6	Pulley holder	Aluminum alloy	
7	Pulley shaft	Stainless steel	Heat treatment + special treatment
8	End pulley	Aluminum alloy	Anodized
9	Motor pulley	Aluminum alloy	Anodized
10	Motor mount	Aluminum die-cast	Painting
11	Motor cover	Synthetic resin	
12	Grommet	Synthetic resin	
13	Motor	-	
14	Motor end brock	Aluminum alloy	Anodized
15	Bearing	-	
16	Bearing	-	
17	Tension plate	Aluminum alloy	Anodized
18	Hexagon bolt	Carbon steel	Chromating
19	Motor cover for lock	Aluminum alloy	Anodized Only "with lock"
20	Grommet	CR	Chloroprene rubber Only "with lock"

No.	Description	Material	Note
21	Guide unit body	Aluminum alloy	Anodized
22	Slide table	Aluminum alloy	Anodized
23	End plate	Aluminum alloy	Anodized
24	Stopper	Carbon steel	Nickel plated
25	Stroke adjuster	Aluminum alloy	Anodized
26	Magnet	-	
27	Side cover	Aluminum alloy	Anodized
28	Cam follower cap	Aluminum alloy	Anodized
29	Cam follower	-	
30	Cam follower	-	
31	Eccentric gear	Stainless steel	
32	Gear fixture	Stainless steel	
33	Adjustment gear	Stainless steel	
34	Rail	Hard steel wire material	

(3) LEMH / LEMHT

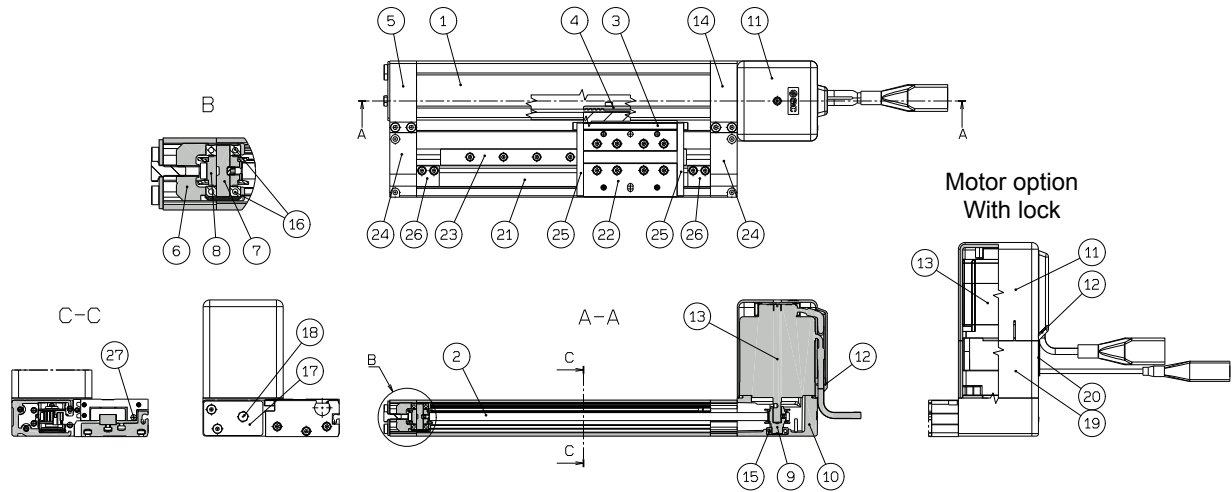

LEMH

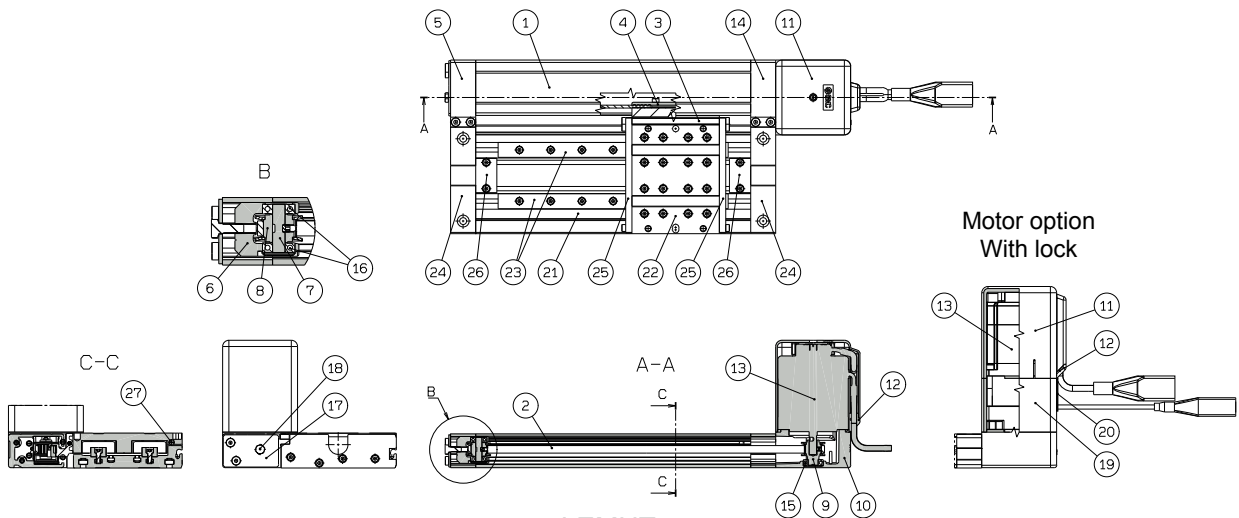

LEMHT

No.	Description	Material	Note
1	Body	Aluminum alloy	Anodized
2	Belt	-	
3	L shaped bracket	Aluminum alloy	Anodized
4	Belt stopper	Aluminum alloy	Anodized
5	End brock	Aluminum alloy	Anodized
6	Pulley holder	Aluminum alloy	
7	Pulley shaft	Stainless steel	Heat treatment + special treatment
8	End pulley	Aluminum alloy	Anodized
9	Motor pulley	Aluminum alloy	Anodized
10	Motor mount	Aluminum die-cast	Painting
11	Motor cover	Synthetic resin	
12	Grommet	Synthetic resin	
13	Motor	-	
14	Motor end brock	Aluminum alloy	Anodized
15	Bearing	-	
16	Bearing	-	
17	Tension plate	Aluminum alloy	Anodized
18	Hexagon bolt	Carbon steel	Chromating
19	Motor cover for lock	Aluminum alloy	Anodized Only "with lock"
20	Grommet	CR	Chloroprene rubber Only "with lock"

No.	Description	Material	Note
21	Guide unit body	Aluminum alloy	Anodized
22	Slide table	Aluminum alloy	Anodized
23	Guide	-	
24	End plate	Aluminum alloy	Anodized
25	Stopper	Carbon steel	Nickel plated
26	Stroke adjuster	Aluminum alloy	Anodized
27	Magnet	-	

3. Product Outline

3.1 System construction

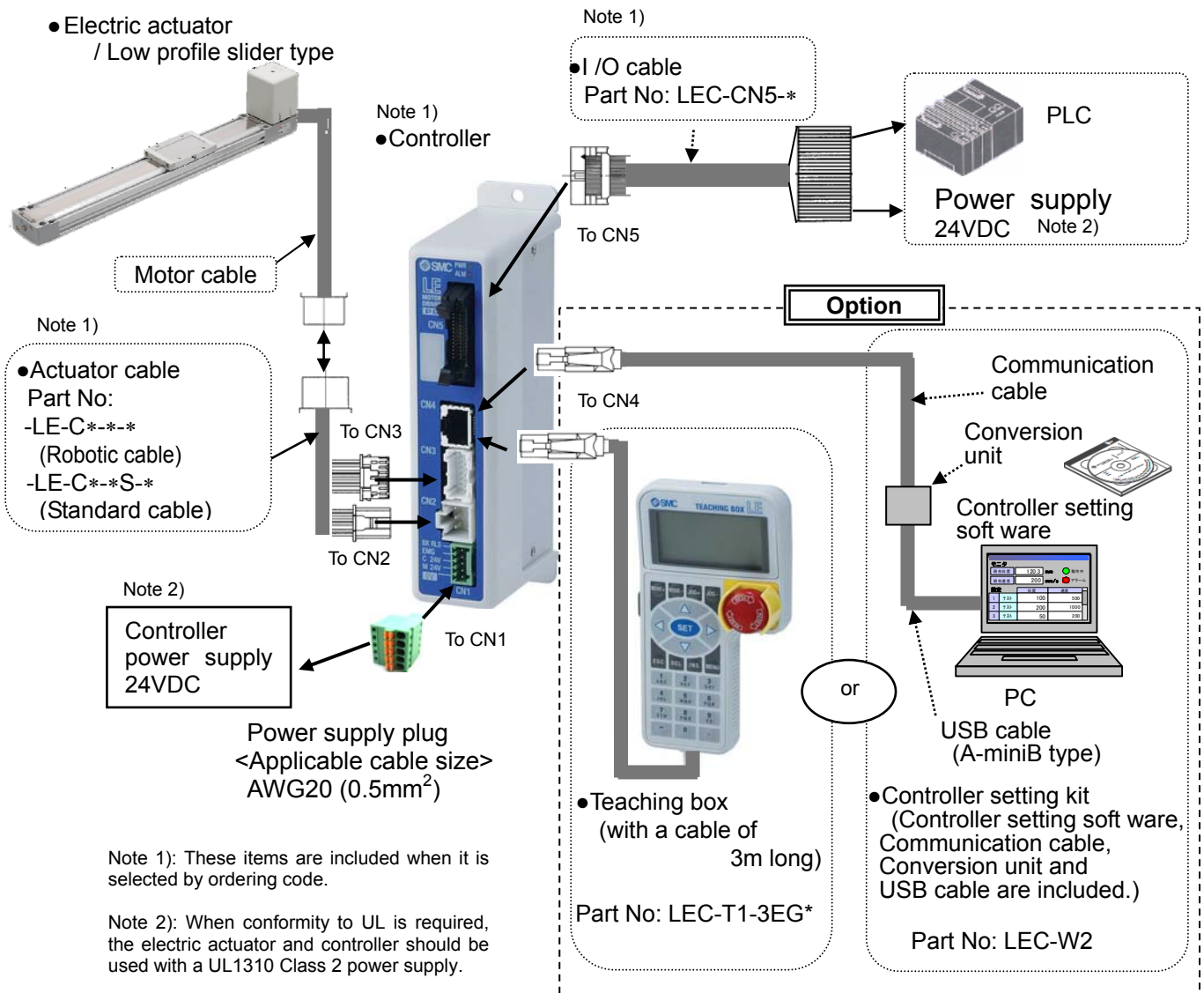

⚠ Warning

Refer to the operation manual of the LEC (controller) for detailed wiring.

/ See 4 Wiring of cables on page 30.

Communication cable is to be connected to PC by USB cable through conversion unit.

Do not connect the teaching box directly to the PC.

Use only specified cables otherwise there maybe fire risk and damage.

The actuator and controller are sold as a package.

If when only the actuator is purchased separately, confirm that the combination of the controller, which you have and the actuator is compatible.

/ See 5.3 Caution (1) on page 33.

<Be sure to check the following before use.>

(1) Check that actuator label for model number.

This matches the controller.

(2) Check Parallel I/O configuration matches (NPN or PNP).

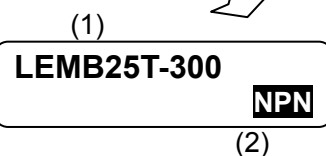

3.2 Setting Function

Refer to the operation manual of the controller (LEC series) for the detail of the setting function.

Easy Mode for simple setting

>Select “Easy mode” for instant operation.

Controller setting software

- Setting and operation, such as the step data setting, test drive and JOG / fixed-distance moving, can be performed on the same page.

Annotations for the Easy Mode interface:

- JOG moving (points to the Drive button)
- Start testing (points to the Test button)
- Positioning data setting (points to the Step data table)
- Fixed distance moving (points to the Move distance field)
- Speed setting of JOG / fixed distance (points to the Move Speed slider)

Teaching box

- Setting and operation by the simple screen without scrolling.
- Select function by the iconized menu at the first page.
- Step data setting and monitoring at the second page.

1st screen

2nd screen

Data	Axis 1
Step No.	0
Posn	123.45mm
speed	400mm/s

It can be registered by “SET” after entering the values.

Example of setting the step data

1st screen

2nd screen

Monitor	Axis 1
Step No.	1
Posn	12.34mm
speed	50mm/s

Operation status can be checked

Example of checking the operation status

Normal mode for the detailed setting

> **Select "Normal mode" if the detailed setting are necessary.**

- Step data can be set in detail.
- Parameters can be set.
- Signals and terminal condition can be monitored.
- JOG and fixed distance movement, return to origin position, test operation and testing of compulsory output can be done.

Controller setting software

- Every function, step data, parameter, monitor and teaching are indicated in a different window.

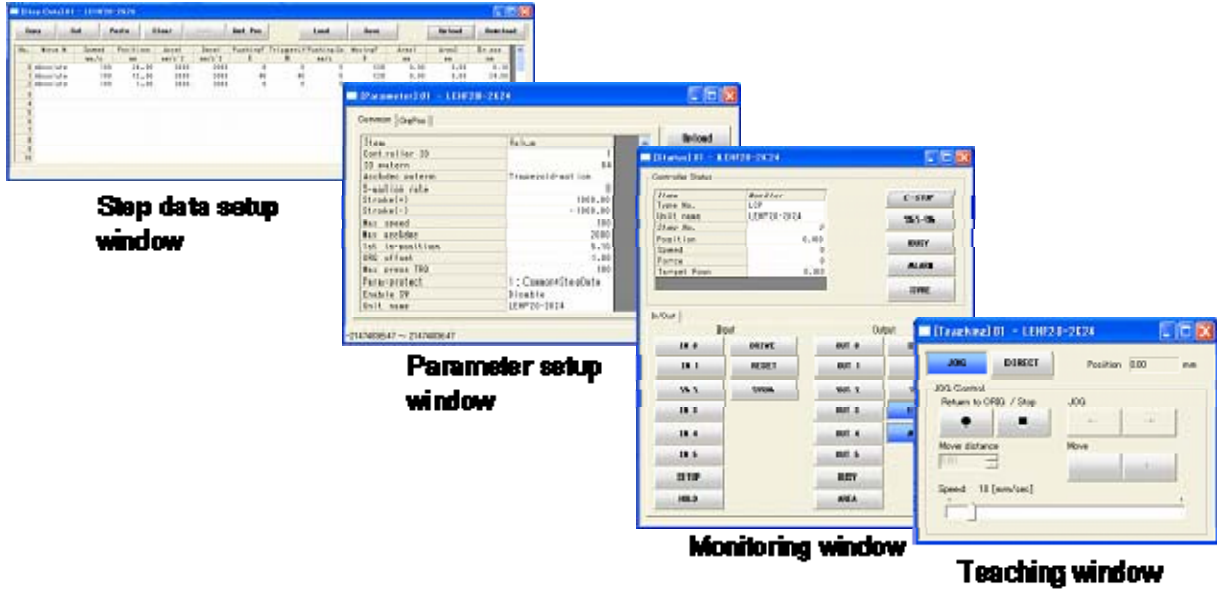

Teaching box

- The data in the controller can be saved / forwarded in this teaching box.
- Continuous test operation can be made after specifying five step data.

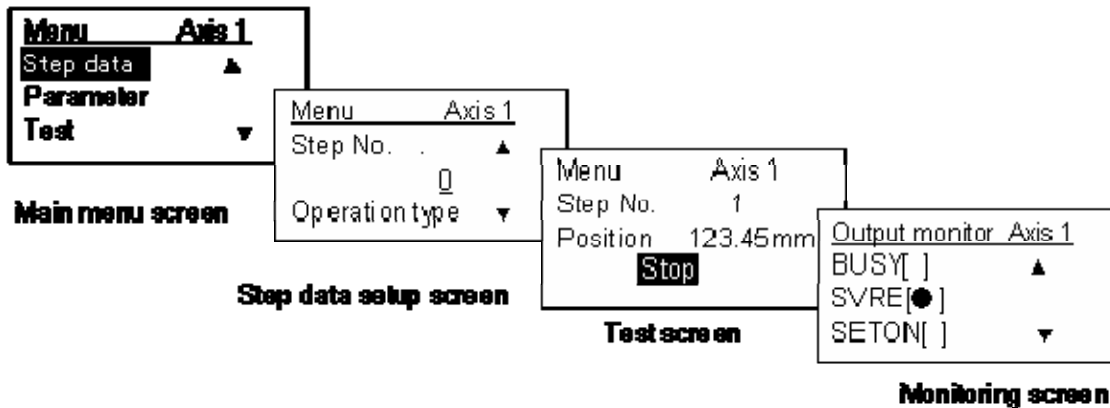

Controlled items

PC: Controller setting software

TB: Teaching box

O: Available function, x: Not available function

Function		Content	Easy mode		Normal mode
			PC	TB	PC
Step data	Movement method	Can be selected of absolute/relative position move	○	×	○
	Speed	Can be set in units of 1mm/s.	○	○	○
	Position	Can be set in units of 0.01mm.	○	○	○
	Acceleration Deceleration	Can be set in units of 1mm/s ² .	○	○	○
	Pushing force	Can be set in units of 1%. / In case of positioning operation: Set to 0%. (Not available in this product)	×	×	×
	Trigger LV	Trigger level of target pushing force when pushing operation Can be set in units of 1%. (Not available in this product)	×	×	×
	Pushing speed	Can be set in units of 1mm/s. (Not available in this product)	×	×	×
	Moving force	100% at step motor, (Not changeable).	○	×	○
	Area output	Can be set in units of 0.01mm.	○	×	○
	In position	During positioning operation: Width to the target position. It should be set to 1 or more.	○	×	○
Parameter (Excerpt)	Stroke(+)	+ side limit of position. (Can be set in units of 0.01mm).	×	×	○
	Stroke(-)	- side limit of position (Can be set in units of 0.01mm).	×	×	○
	ORIG direction	Direction when returning to home position can be set.	×	×	○
	ORIG speed	Speed when returning to home position can be set.	×	×	○
	ORIG ACC	Acceleration when returning to origin can be set.	×	×	○
Test	JOG	It can make continuous operation at the set speed while the switch is being pressed	○	○	○
	MOVE	It can make test operation at the set distance and speed from the current position when the switch is pressed.	○	×	○
	Return to ORIG	Test of return to origin can be done.	○	○	○
	Test drive	The operation of the specified step data can be tested.	○	○	○ (Continuous operation)
	Forced output	ON/OFF of the output terminal can be tested.	×	×	○
Monitor	DRV mon	Current position, current speed, current force and the specified step data No. can be monitored.	○	○	○
	In/Out mon	Current ON/OFF status of the input and output terminal can be monitored.	×	×	○
ALM	Status	The alarm currently being generated can be confirmed.	○	○	○
	ALM Log record	The alarm generated in the past can be confirmed.	×	×	○
File	Save - Load	The step data and parameter of the objective controller can be saved, forwarded and deleted.	×	×	○
Other	Language	Language can be changed to Japanese / English.	○ *3	○ *2	○ *2 *3

*1 Every parameter is set to the recommended condition before shipment from the factory. Only change the setting of the items which require adjustment.

*2 Teaching box: In the Normal mode the teaching box can be set to work in English or Japanese.

*3 Controller setting software: Can be installed by selecting English version or Japanese version.

3.3 Step data setting method

Refer to the operation manual of the controller (LEC series) for details.

This operation manual specifies the electric actuator guide rod slider, if an actuator other than the guide rod slider is used, refer to the operation manual of each type of actuator and controller (LEC series) regarding the description of step data.

⚠ Caution

The actuator body and controller are sold as a package.

If when only the actuator is purchased separately, confirm that the combination of the controller, which you have and the actuator is compatible. / See 5.3 ⚠ Caution(1) on page 33

<Be sure to check the following before use.>

- (1) Check that actuator label for model number.
This matches the controller.
- (2) Check Parallel I/O configuration matches (NPN or PNP).

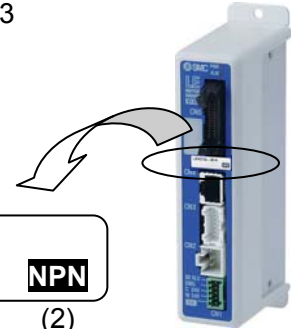
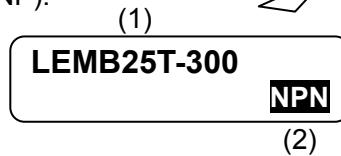

Positioning operation

In the positioning operation, the actuator transfers to and stops at the target position.
The following image shows the set items and operation.

<Confirmation of reaching the target position during the positioning operation>

When the table of actuator reaches the range of the target position, the “target position reaching signal” 【INP】 (in position) is outputted.

When the table of actuator enters the range of 【in position】, the INP output signal turns on.

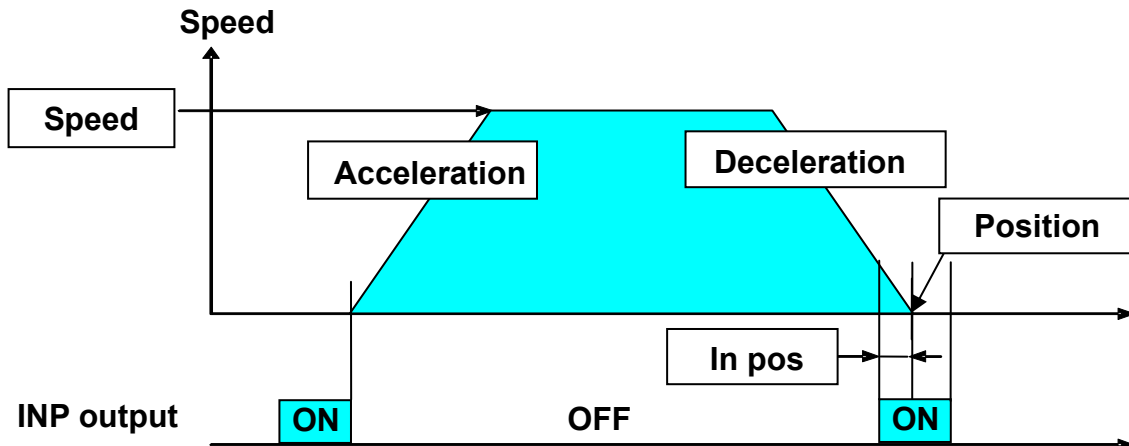

<Items and set values in positioning operation>

Step No. 1: Positioning operation

	a	b	c	d	e	f	g	h	i	j	k	
No.	Move M	Speed mm/s	Position mm	Accel mm/s ²	Decel mm/s ²	Pushing F %	TriggLV %	Pushing Sp mm/s	Moving F %	Area 1 mm	Area 2 mm	In posn mm
0	Absolute	500	100.00	2500	2500	0	0	0	100	0.00	0.00	1.00
1	Absolute	500	0.00	2500	2500	0	0	0	100	0.00	0.00	1.00

[◎] Need to be set - [○] Need to be adjusted as required.

[×] Not used. Items don't need to be changed in positioning operation.

a < ◎ Movement MOD > When the absolute position is required, set Absolute
When the relative position is required, set Relative
→ Absolute: Distance from the origin position. / General setting method
Relative: Feed from the current position. / This is used when simplified data.

b < ◎ Speed > Transfer speed to the target position.

c < ◎ Position > Target position.

d < ○ Acceleration > The parameter which defines how rapidly the actuator reaches the speed set in b.
The higher the set value, the faster it reaches the speed set in b.

e < ○ Deceleration > The parameter which defines how rapidly the actuator comes to stop.
The higher the set value, the quicker it stops.

f < ◎ Pushing force > Set **0**.
(If values other than 0 set the operation will be changed to the pushing operation.)

g < × Trigger LV > For pushing operation only. Not applicable for this product.

h < × Pushing speed > For pushing operation only. Not applicable for this product.

i < × Moving force > Max. Force at the positioning operation.
The force is automatically adjusted corresponding to the load.
Set [100] % at step motor. (Not changeable)

j < ○ Area1, Area2 > This is the condition that turns on the AREA output signal.
The setting condition should be **Area 1 < Area 2**
It is possible to set at relative operation too.
The position will be Absolute (position from the origin).

Example) In case of Step no.1

[AREA] output signal is outputted between Area 1: 0 and Area 2: 2.

k < ○ In position > This is the condition that turns on the INP (in position) output signal.
→ When the electric actuator reaches the range of the target position, the INP output signal is output.

When it is necessary to output the target position reaching signal earlier, make the value larger.

Note) Set the value more than [1] (Default).

Example) In case of Step no.1

Position: 0 + In position: 1 = [INP] is outputted from the value of 1.

Example of step data input (1)

< Positioning operation - 【INP】output signal, 【AREA】output signal >

No.	Move M	Speed mm/s	Position mm	Accel mm/s ²	Decel mm/s ²	PushingF %	TriggerLV %	PushingSp mm/s	MovingF %	Area1 mm	Area2 mm	In posn mm
0	Absolute	100	100.00	3000	3000	0	0	0	100	80.00	90.00	1.00

- **Step data no.0: Positioning operation (It moves from Position: 0[mm] to Position: 100[mm])**

Condition 1) The 【AREA】output signal is not used.

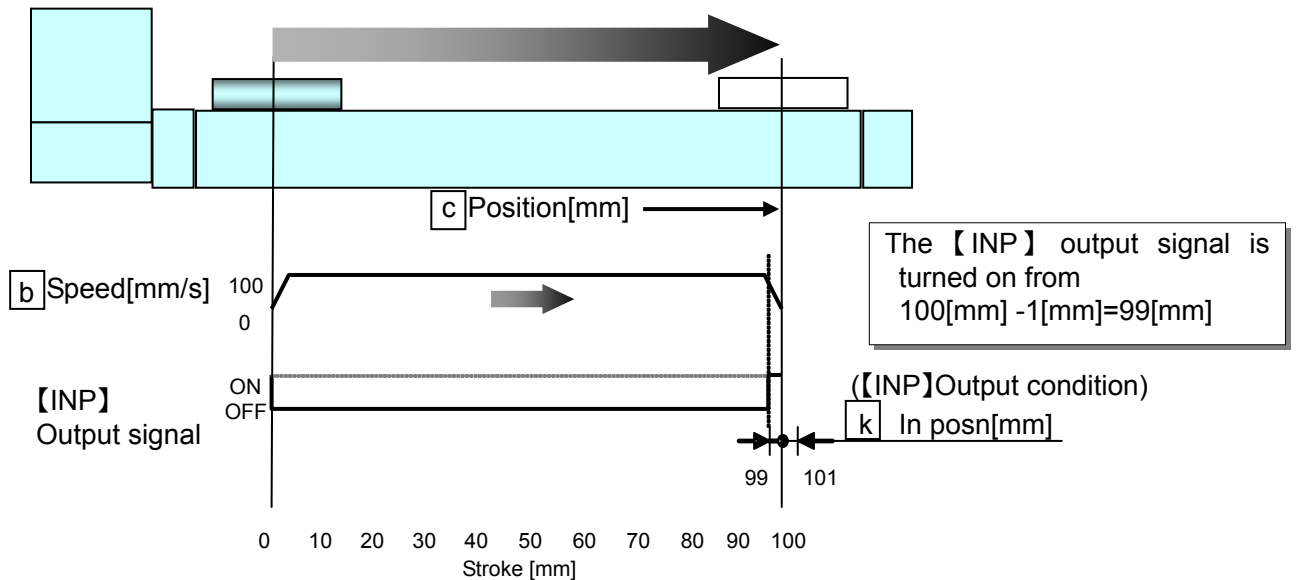

Condition 2) The 【AREA】output signal is used.

*The 【AREA】output signal is a signal output when the table traverses through a certain range (The step data: from **Area 1** to **Area 2**).

This feature is useful when an output to check the table position at intermediate stroke is required.

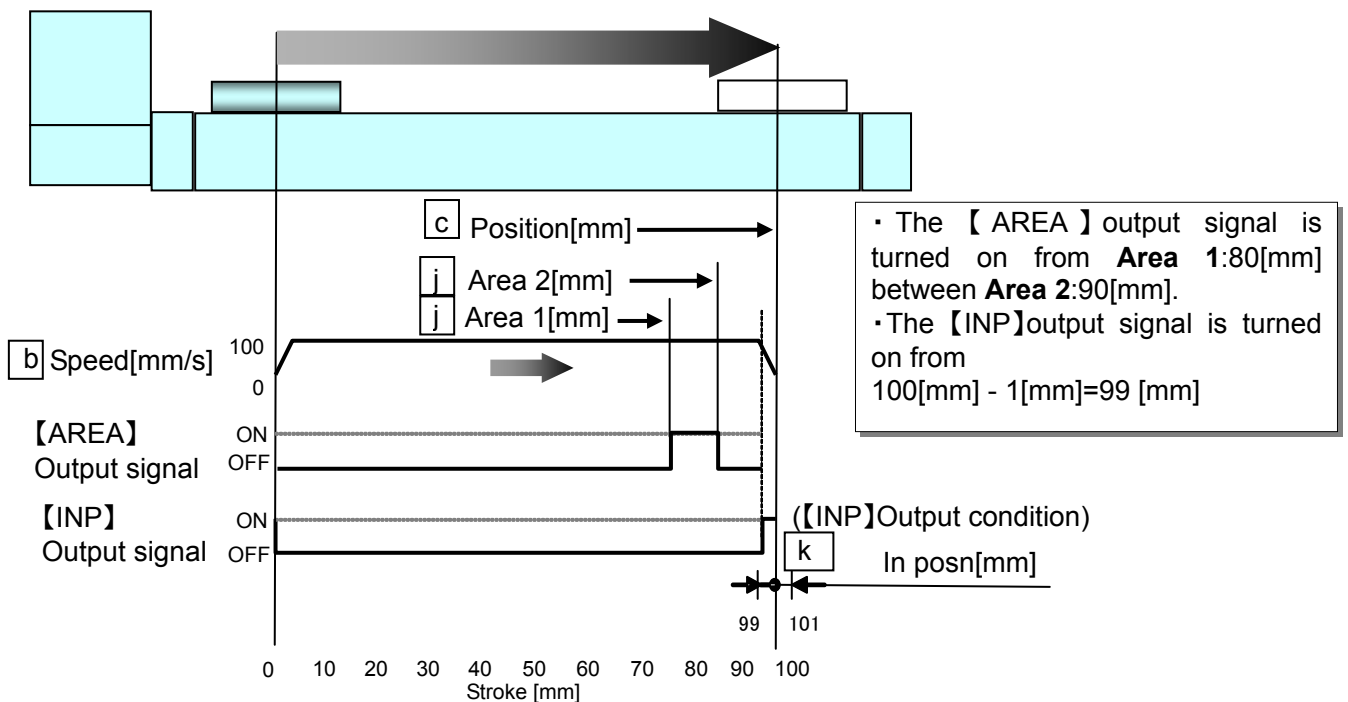

Example of step data input (2)

< Positioning operation – Relative >

	a	b	c	d	e	f	g	h	i	j	k	
No.	Move M	Speed	Position	Accel	Decel	PushingF	TriggerLV	PushingSp	MovingF	Area1	Area2	In posn
		mm/s	mm	mm/s ²	mm/s ²	%	%	mm/s	%	mm	mm	mm
0	Relative	100	10.00	3000	3000	0	0	0	100	10.00	20.00	1.00
1	Relative	100	-10.00	3000	3000	0	0	0	100	10.00	20.00	1.00

*Absolute: Distance from the origin position. / General setting method

*Relative: Feed from the current position. / This is used when simplified data.

Condition 1) 30mm position → **Step no.0** → **Step no.0** (Move Method: Relative)

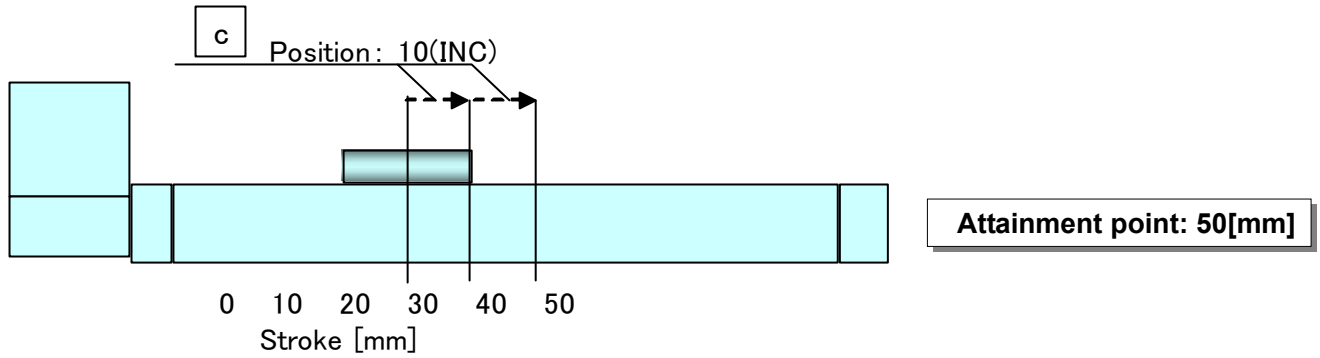

Condition 2) 30mm position → **Step no.1** → **Step no.1** (Move Method: Relative)

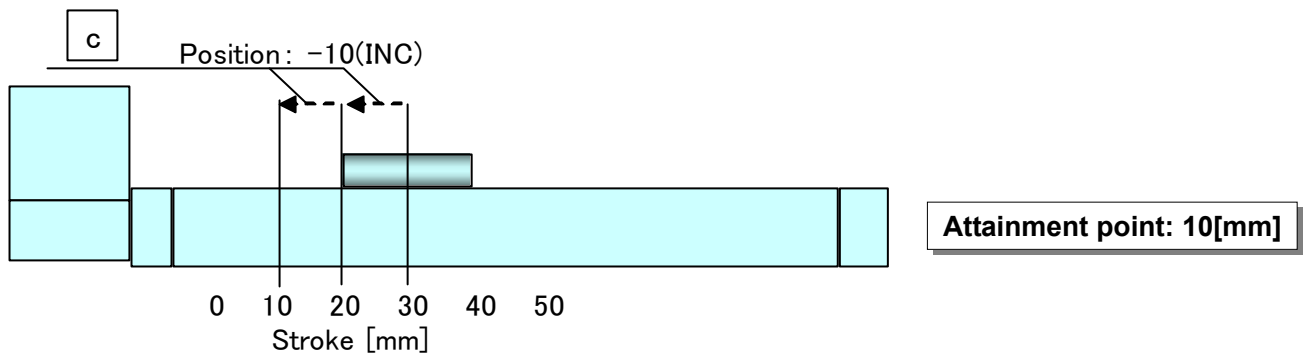

Operating procedure and input / output signals for each operation

The input / output signal and the operation description for operating this electric actuator are as follows.

1) Signals along with the operation procedures

In case the operation order is

1. Supply power to the motor → 2. Return to origin → 3. Step no. 1 → 4. Step no. 2 → 5. Cut power to the motor

Procedure	Input signal	Output signal for the input signal	Operation description
1	SVON(Servo on)[●]	SVRE(Servo ready) [●]	Power is supplied to the motor, and detection of the magnetic pole position starts. => Completion.
2	SETUP [●]	SETON [●] INP(In position)[●]	Returning to the origin starts. =>Completion.
3	IN0 [●] IN1 [] IN2 [] IN3 [] IN4 [] IN5 [] ↓ DRIVE [●] => [] note.3)5)	OUT0 [●] OUT1 [] OUT2 [] OUT3 [] OUT4 [] OUT5 [] } note.3)4) ↓ After reaching of target position, INP [●] After stopping motion, BUSY []	Step no. 1 is selected, and the operation starts. =>Complete.
4	IN0 [] IN1 [●] IN2 [] IN3 [] IN4 [] IN5 [] ↓ DRIVE [●] => [] note.3)5)	OUT0 [] OUT1 [●] OUT2 [] OUT3 [] OUT4 [] OUT5 [] } note.3)4) ↓ After reaching of target position, INP [●] After stopping motion, BUSY []	Step no. 2 is selected, and the operation starts. =>Complete.
5	SVON []	SVRE [] SETON [●] note.2) INP [●]	Power to the motor is cut.

Note 1) [●] means ON, [] means OFF.

Note 2) The origin has been recognized when the operation is repeated, so it can operate without the procedure item 2.

Note 3) The "OUT*" signals are reset during the rising edge of the Drive signal. The "OUT*" signal which follows the "IN*" signal are outputted at the falling edge of the "drive" signal.

Note 4) When the alarm is generated, the alarm group is displayed.
Please confirm the controller (LEC series) manual for a detailed content of the alarm.
The alarm becomes invalid when the "EMG"(Stop) or "RESET" is commanded.

Note 5) Leave an interval of 15ms (the recommendation is 30ms) or more between input signals and maintain the state of the signal for 15ms (the recommendation is 30ms) or more, because PLC processing delays and controller scanning delays can occur.

2) Signals when Stopped: In the event when “EMG” is used

/ See 5.1 Warning (9) on page 31

The operating sequence is 1. “Stop” → 2. Release the “Stop”

Procedure	Input signal	Output signal for the input signal	Operation description
1	EMG: Not energizing (TB / Stop switch: Locking)	*ESTOP[] SVRE [] SETON [●]	Power to the motor is cut by the “Stop” command regardless of whether it is operating or stopping.
2	EMG: Energizing (TB / Stop switch: Releasing)	*ESTOP[●] SVRE [●] SETON [●] Note 2)	The stop is released.

Note 1) [●] means ON, [] means OFF and *means negative logic.
TB means teaching box.

Note 2) SETON signal does not change after releasing the “STOP”.

3.4 Parameter setting method

Initial setting for the basic parameters

Refer to the controller's (LEC series) operation manual for detail.

As the "basic parameter" is unique data of each actuator, if an actuator other than the "electric actuator / Low profile slider type" is used, refer to the operation manual of each actuator and the controller's (LEC series) operation manual for the basic parameter.

Description(Extract)	Initial input value	Input range
Controller ID	1	1 to 64 note 1)
IO pattern	1: 64	-
ACC / DEC pattern	2	-
S-motion rate	LEM*25: 10, LEM*32: 20	-
Stroke (+)	10000	10000
Stroke (-)	-10000	-10000
Max speed	Max. speed of each product	Step data input limit: Max. speed of each product
Max ACC / DEC	2500	to 20000
Def. In positioning	1	1 to product stroke
ORIG offset note 2)	0.00	Origin direction: "1" (End side) -10000 + "product stroke" to 9999 Origin direction: "2" (Motor side) -9999 to +10000 - "product stroke"
Max force	-	-
Para protect	1: Common + StepData	Changeable parameter 1: Common + StepData, 2: Common
Enable SW	2: Disable	Select 1: Enable or 2: Disable when using a teaching box
Unit name	Part no. of each product	Only the English characters and numbers are changeable.
W-AREA1	0.00	-
W-AREA2	0.00	-
ORG Correct	0.00	-

Note 1) Become effective after restarting the controller.

Note 2) The origin offset is used for the "return to origin". / See <Origin offset> on page 29.

Initial setting for the ORIG parameters

Refer to the controller's (LEC series) operation manual for detail.

As the "ORIG parameter" is unique data of each actuator, if an actuator other than the "electric actuator / Low profile slider type" is used, refer to the operation manual of each actuator and the controller's (LEC series) operation manual for the "ORIG parameters".

Description(Extract)	Initial input value	Input range
ORIG direction	2 note 1)	1, 2
ORIG mode	1: Stop	-
ORIG limit	50	-
ORIG time	200	-
ORIG speed	60	-
ORIG ACC /DEC	500	-
Creep speed	60	-
ORIG sensor	0: Disable	-

Note1) 1: end side origin, 2: motor side origin,. Become effective after restarting the controller.

Note2) Return to origin cannot be done during operation. / See 5.1. precautions⚠ caution 4. on page 32.

<Return to origin>

It is necessary to establish the origin before commencing any other operation.

1) Sequence of return to origin

Input the origin signal → Move to the origin → Stop moving (pushing) → Move to the opposite direction → Origin
(Moving distance: 3mm, not changeable)

⚠ WARNING

Do not alter any parameter except the ones shown. Or else there is a possibility of damage.

2) Method of changing direction of origin

Use the following procedures when you change the direction of the origin. Initial setting of origin is motor side.

Procedure 1- In the [Parameter] 01 dialogue box select the ORIG tab.

And the direction of the origin is changed from "2" to "1".

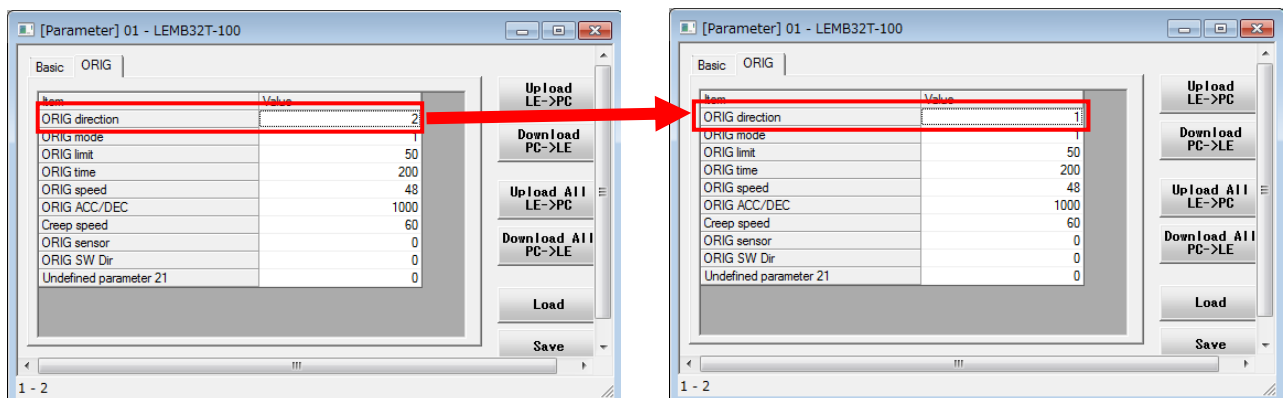

Procedure 2- In the [Parameter] 01 dialogue box press the "Download All" radio button.

Procedure 3- Power supply OFF (→ Power supply ON)

<Origin offset>

The origin offset means the value of the origin. ("Origin offset"=The display value of origin)
 When the parameter "Origin offset" is changed, the display value of origin is changed. The step data should be checked again.
 Please refer to "Initial setting for the basic parameters" on page 27 for changing of "ORIG offset".
 Initial input value: "Origin offset"=0. Move in the opposite direction: 3mm (Not changeable) by the return to origin becomes "origin =0".

a) In case of Origin direction: "2" (Motor side)

Example) Actuator stroke 50mm
 "Origin offset"=0 (Initial input value)

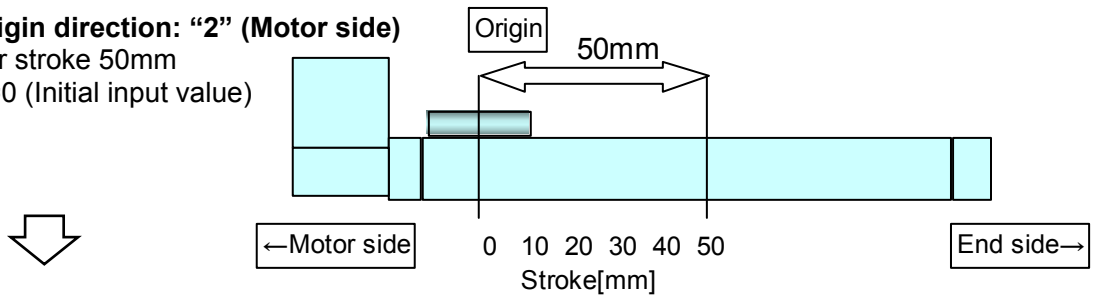

Changed to "Origin offset"=10

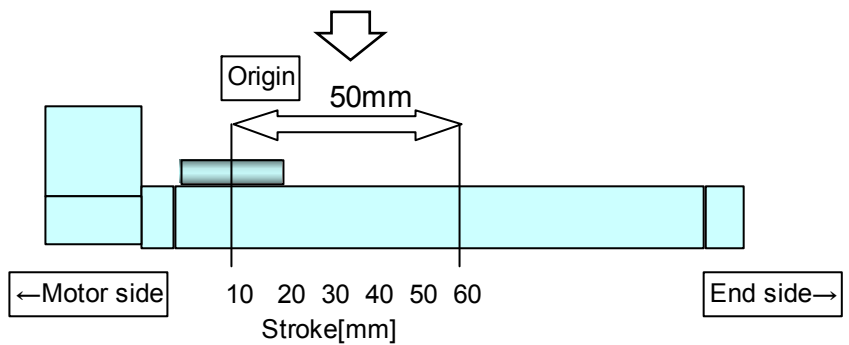

b) In case of Origin direction: "1" (End side)

Example) Actuator stroke 50mm
 "Origin offset"=0 (Initial input value)

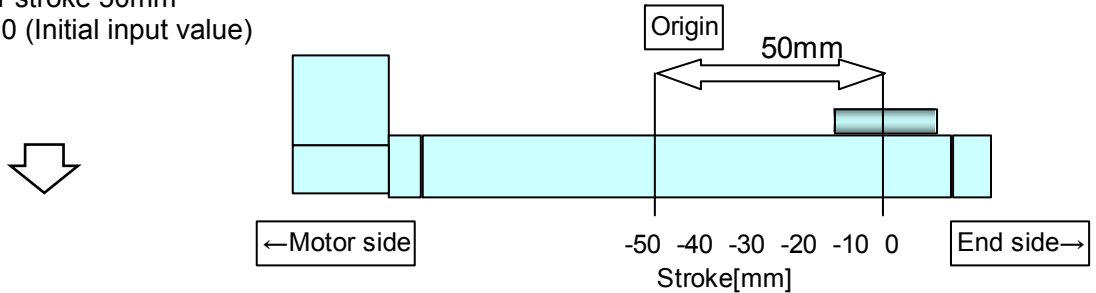

Changed to "Origin offset"=10

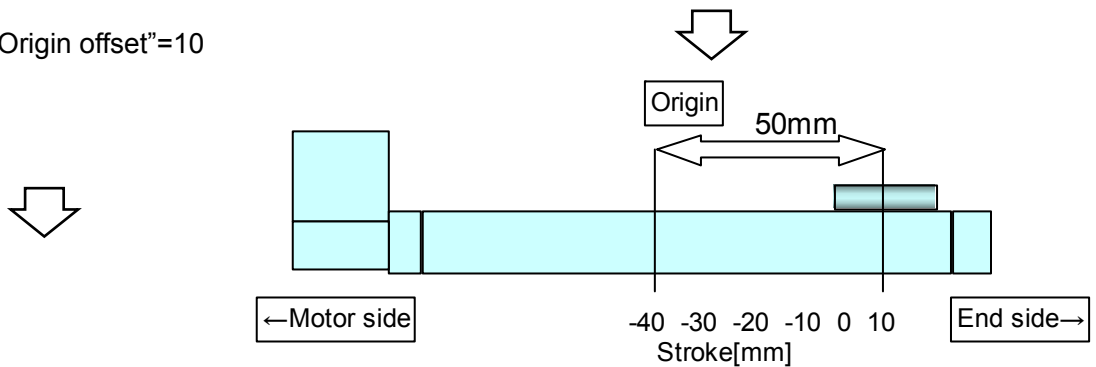

Changed to "Origin offset"=-10

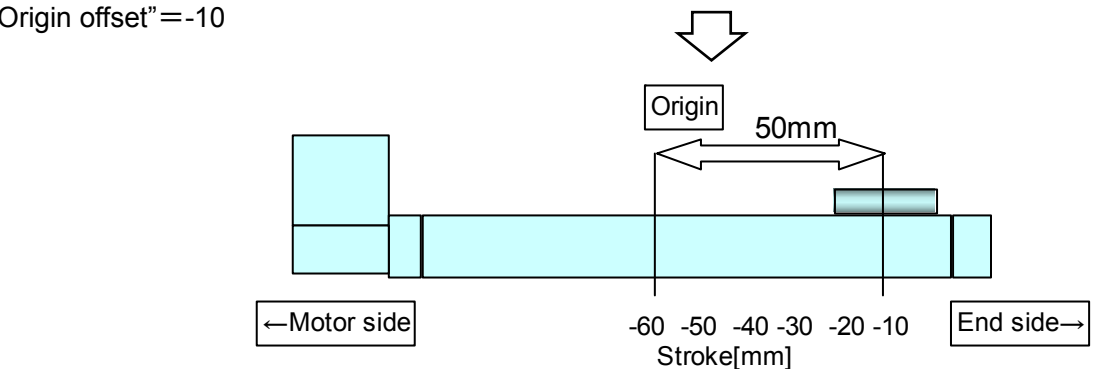

4. Wiring of cables / Common precautions

Warning

1. **Adjusting, mounting or wiring change should never be done before disconnecting the power supply to the product.**
Electrical shock, malfunction and damage can result.
2. **Do not disassemble the cables.**
Use only specified cables.
3. **Do not connect or disconnect the wires, cables and connectors when the power is turned on.**

Caution

1. **Wiring securely. Do not apply any voltage to the terminals other than those specified in the Operation Manual.**
2. **Wire the connector securely.**
3. **Take appropriate measures against noise.**
Noise in a signal line may cause malfunction. As a countermeasure separate the high voltage and low voltage cables, and shorten the wiring lengths, etc.
4. **Do not route input/output wires and cables together with power or high voltage cables.**
The product can malfunction due to interference of noise and surge voltage from power and high voltage cables to the signal line. Route the wires of the product separately from power or high voltage cables.
5. **Take care that actuator movement does not catch cables.**
6. **Operate with all wires and cables secured. Avoid bending cables at sharp angles where they enter the product.**
7. **Avoid twisting, folding, rotating or applying an external force to the cable.**
Risk of electric shock, wire breakage, contact failure and loss of control of the product can happen.
8. **Fix the motor cables protruding from the actuator in place before use.**
The motor and lock cables are not robotic type cables and can be damaged when moved. Therefore fix the cables and the connectors (part "A" in figure below) when set up.

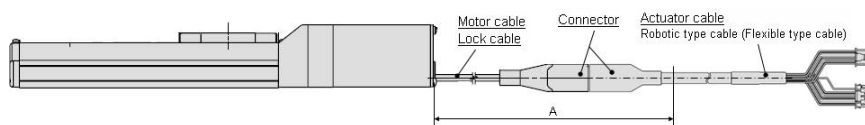

9. **Select "Robotic cables" in case of inflecting actuator-cable repeatedly. And do not put cables into a flexible moving tube with a radius smaller than the specified value. (Min. 50mm).**

Risk of electric shock, wire break, contact failure and loss of control for the product can happen if "Standard cables" are used in case of inflecting the cables repeatedly.

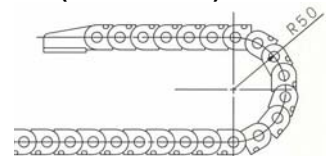

10. **Confirm proper wiring of the product.**

Poor insulation (interference with other circuits, poor insulation between terminals and etc.) can apply excessive voltage or current to the product causing damage.

11. **The Speed / pushing force may vary, depending on the cable length, load and mounting conditions etc.**

If the cable length exceeds 5m, the speed/pushing force will be reduced 10% per 5m as the maximum.(if cable length is 15m: 20% reduction as the maximum.)

[Transportation]

Caution

1. **Do not carry or swing the product by the motor or the cables.**

5. Electric actuators / Common precautions

5.1 Design and selection

Warning

- 1. Be sure to read the operation manual (this manual and the one for the controller: LEC series).**
Handling or usage/operation other than that specified in the Operation Manual may lead to breakage and operation failure of the product.
Any damage attributed to the use beyond the specifications is not guaranteed.
- 2. There is a possibility of dangerous sudden action by the product if sliding parts of machinery are twisted due to external forces etc.**
In such cases, human injury may occur, such as by catching hands or feet in the machinery, or damage to the machinery itself may occur. Design the machinery should be designed to avoid such dangers.
- 3. A protective cover is recommended to minimize the risk of personal injury.**
If a driven object and moving parts of the product are in close proximity, personal injury may occur. Design the system to avoid contact with the human body.
- 4. Securely tighten all stationary parts and connected parts so that they will not become loose.**
When the product operates with high frequency or is installed where there is a lot of vibration, ensure that all parts remain secure.
- 5. Consider a possible loss of power source.**
Take measures to prevent injury and equipment damage even in the case of a power source failure.
- 6. Consider behavior of emergency stop of whole system.**
Design the system so that human injury and/or damage to machinery and equipment will not be caused, when it is stopped by a safety device for abnormal conditions such as a power outage or a manual emergency stop of whole system.
- 7. Consider the action when operation is restarted after an emergency stop or abnormal stop of whole system.**
Design the system so that human injury or equipment damage will not occur upon restart of operation of whole system.
- 8. Disassembly and modification is prohibited**
Do not modify or reconstruct (including additional machining) the product. An injury or failure can result.
- 9. Do not use the stop signal, "EMG" of the controller and stop switch on the teaching box as the emergency stop of system.**
The stop signal, "EMG" of controller and the stop switch on the teaching box are for decelerating and stopping the actuator.
Design the system with an emergency stop circuit which is applied relevant safety standard separately.
- 10. When using it for vertical application, it is necessary to build in a safety device.**
The table may fall due to the weight of work. The safety device should not interfere with normal operation of the machine.

Caution

- 1. Operate within the limits of the maximum usable stroke.**
The product will be damaged if it is used with the stroke which is over the maximum stroke. Refer to the specifications of the product.
- 2. When the product repeatedly cycles with partial strokes, operate it at a full stroke at least once a day or every 1000 strokes.**
Otherwise, lubrication can run out.

3. **Do not use the product in applications where excessive external force or impact force is applied to it.**
The product can be damaged. Each component that includes motor is made with accurate tolerance. So even slightly deformed or miss-alignment of component may lead operation failure of the product.
4. **Returning to origin cannot be done during the operation.**
It cannot be done during positioning operation, pushing operation and pushing.
5. **Refer to a common auto switch /matter (Best Pneumatics No 2) when an auto switch is built in and used.**
6. **When conformity to UL is required, the electric actuator and controller should be used with a UL1310 Class 2 power supply.**

5.2 Mounting

Warning

1. **Install and operate the product only after reading the Operation Manual carefully and understanding its contents. Keep the manual in a safe place for future reference.**
2. **Observe the tightening torque for screws.**
Unless stated otherwise, tighten the screws to the recommended torque for mounting the product.
3. **Do not make any alterations to this product.**
Alterations made to this product may lead to a loss of durability and damage to the product, which can lead to human injury and damage to other equipment and machinery.
4. **When using external guide, the guide axis should be parallel to the actuator axis.**
There will be damage/excessive wear on the lead screw if the external guide is not parallel.
5. **When an external guide is used, connect the moving parts of the product and the load in such a way that there is no interference at any point within the stroke.**
Do not scratch or dent the sliding parts of the table or mounting face etc., by striking or holding them with other objects. The components are manufactured to precise tolerances, so that even a slight deformation may cause faulty operation or seizure.
6. **Prevent the seizure of rotating parts.**
Prevent the seizure of rotating parts (pins, etc.) by applying grease.
7. **Do not use the product until you verify that the equipment can be operated correctly.**
After mounting or repair, connect the power supply to the product and perform appropriate functional inspections to check it is mounted correctly.
8. **Cantilever**
When the actuator is operated at high speed while it is fixed at one end and free at the other end (flange type, foot type, double clevis type, direct mount type), a bending moment may act on the actuator due to vibration generated at the stroke end, which can damage the actuator. In such a case, install a support bracket to suppress the vibration of the actuator body or reduce the speed so that the actuator does not vibrate. Use a support bracket also when moving the actuator body or when a long stroke actuator is mounted horizontally and fixed at one end.
9. **When mounting the actuator or attaching to the work piece, do not apply strong impact or large moment.**
If an external force over the allowable moment is applied, it may cause looseness in the guide unit, an increase in sliding resistance or other problems.
10. **Maintenance space**
Allow sufficient space for maintenance and inspection.

5.3 Handling

Warning

- 1. Do not touch the motor while in operation.**

The surface temperature of the motor can increase to approx. 90°C to 100°C due to operating conditions. Energizing alone may also cause this temperature increase. As it may cause burns, do not touch the motor when in operation.
- 2. If abnormal heating, smoking or fire, etc. occurs in the product, immediately turn off the power supply.**
- 3. Immediately stop operation if abnormal operation noise or vibration occurs.**

If abnormal operation noise or vibration occurs, the product may have been mounted incorrectly. Unless operation of the product is stopped for inspection, the product can be seriously damaged.
- 4. Never touch the rotating part of the motor or the moving part of the actuator while in operation.**
- 5. When installing, adjusting, inspecting or performing maintenance on the product, controller and related equipment, be sure to turn off the power supply to each of them. Then, lock it so that no one other than the person working can turn the power on, or implement measures such as a safety plug.**

Caution

- 1. Keep the controller and product combined as delivered for use.**

The product is set in parameters for shipment. If it is combined with a different product parameter, failure can result.
- 2. Check the product for the following points before operation.**
 - a) Damage to power supply line and signal line.
 - b) Looseness of the connector to each power line and signal line.
 - c) Looseness of the actuator /cylinder and controller /driver mounting
 - d) Abnormal operation
 - e) Emergency stop of the total system
- 3. When more than one person is performing work, decide on the procedures, signals, measures and resolution for abnormal conditions before beginning the work. Also, designate a person to supervise work other than those performing work.**
- 4. Actual speed of the product will be changed by the workload.**

Before selecting a product, check the catalog for the instructions regarding selection and specifications.
- 5. Do not apply a load, impact or resistance in addition to a transferred load during return to origin.**

In the case of the return to origin by pushing force, additional force will cause displacement of the origin position since it is based on detected motor torque.
- 6. Do not remove the nameplate.**
- 7. Operation test should be performed by low speed. Start operation by predefined speed after confirming there are no problems.**

[Earth]

Warning

- 1. Please give the earth to the actuator.**
- 2. Please make it to the earth of exclusive use. The earth construction is D seed.**

(Below earth resistance 100Ω)
- 3. Please shorten the distance until the actuator and earth.**

[Unpackaging]

Caution

1. **Check the received product is as ordered.**
If the different product is installed from the one ordered, injury or damage could result.

5.4 Operating environment

Warning

1. **Avoid use in the following environments.**
 - a. Locations where a large amount of dusts and cutting chips are airborne.
 - b. Locations where the ambient temperature is outside the range (refer to specifications).
 - c. Locations where the ambient humidity is outside the range (refer to specifications).
 - d. Locations where corrosive gas, flammable gas, sea water, water and steam are present.
 - e. Locations where strong magnetic or electric fields are generated.
 - f. Locations where direct vibration or impact is applied to the product.
 - g. Areas that are dusty, or are exposed to splashes of water and oil drops.
 - h. Areas exposed to direct sunlight (ultraviolet ray).
2. **Do not use in an environment where the product is directly exposed to liquid, such as cutting oils.**
If cutting oils, coolant or oil mist contaminates the product, failure or increased sliding resistance can result.
3. **Install a protective cover when the product is used in an environment directly exposed to foreign matters such as dust, cutting chips and spatter.**
Play or increased sliding resistance can result.
4. **Shade the sunlight in the place where the product is applied with direct sunshine.**
5. **Shield the product if there is a heat source nearby.**
When there is a heat source surrounding the product, the radiated heat from the heat source can increase the temperature of the product beyond the operating temperature range. Protect it with a cover, etc.
6. **Grease oil can be decreased due to external environment and operating conditions and it deteriorates lubrication performance to shorten the life of the product.**

[Storage]

Warning

1. **Do not store the product in a place in direct contact with rain or water drops or is exposed to harmful gas or liquid.**
2. **Store in an area that is shaded from direct sunlight and has a temperature and humidity within the specified range (-10°C to 60°C and 90%RH or less No condensation).**
3. **Do not apply vibration and impact to the product during storage.**

5.5 Maintenance

Warning

1. **Do not disassemble or repair the product.**
Fire or electric shock can result.
2. **Before modifying or checking the wiring, the voltage should be checked with a tester 5 minutes after the power supply is turned off.**
Electrical shock can result.

Caution

1. **Maintenance should be performed according to the procedure indicated in the Operating Manual.**
Incorrect handling can cause an injury, damage or malfunction of equipment and machinery.
2. **Removal of product**
When equipment is serviced, first confirm that measures are in place to prevent dropping of work pieces and run-away of equipment, etc, and then cut the power supply to the system. When machinery is restarted, check that operation is normal with actuators in the proper positions.

[Lubrication]



Caution

1. **The product has been lubricated for life at manufacturer, and does not require lubrication in service.**

Contact SMC if lubrication will be applied.

5.6 Precautions for actuator with lock



Warning

1. **Do not use the lock as a safety lock or a control that requires a locking force.**
The lock used for the product with a lock is designed to prevent dropping of work piece.
2. **For vertical mounting, use the product with a lock.**
If the product is not equipped with a lock, the product will move and drop the work piece when the power is removed.
3. **"Measures against drops" means preventing a work piece from dropping due to its weight when the product operation is stopped and the power supply is turned off.**
4. **Do not apply an impact load or strong vibration while the lock is activated.**
If an external impact load or strong vibration is applied to the product, the lock will lose its pushing force and damage to the sliding part of the lock or shortening of lifespan can result. The same situations will happen when the lock slips due to a force over the thrust of the product, as this accelerates the wear to the lock.
5. **Do not apply liquid or oil and grease to the lock or its surrounding.**
When liquid or oil and grease is applied to the sliding part of the lock, its pushing force will reduce significantly.
6. **Take measures against drops and check that safety is assured before mounting, adjustment and inspection of the product.**
If the lock is released with the product mounted vertically, a work piece can drop due to its weight.
7. **When the actuator is operated manually (when SVRE output signal is off), supply 24DCV to the [BK RLS] terminal of the power supply connector.**
If the product is operated without releasing the lock, wearing of the lock sliding surface will be accelerated, causing reduction in the holding force and the life of the locking mechanism.
8. **Do not supply 24VDC power to the BK-RLS (lock release) during normal operation.**
The input of 24VDC to the BK-RLS (lock release) is only required for maintenance or installation purposes when the motor is off. If power is supplied constantly to the BK-RLS (lock release) the lock is released all the time and it cannot be activated in a power cut situation or in a stop circuit, and this can cause the workpiece to drop down.

/Refer to the operation manual of LEC (controller) for details of wiring.

6. Electric actuators / Low profile slider type Common precautions

6.1 Design and selection

⚠ Warning

1. Do not apply a load in excess of the actuator specification.

A product should be selected based on the maximum work load and allowable moment. If the product is used outside of the operating specification, eccentric load applied to the guide will become excessive and have adverse effects such as creating play in the guide, reduced accuracy and reduced product life.

2. Do not exceed the acceleration, deceleration and speed limit of the actuator specification.
Select a suitable actuator by the “speed - work load graph” and the “workload – acceleration graph” shown on the catalog.

Noise or reduction of accuracy may occur if the actuator is operated in excess of its specification and could lead to reduced accuracy and reduced product file.

3. Do not use the product in applications where excessive external force or impact force is applied to it.

This can lead to premature failure of the product.

4. Do not apply excessive external force or impact force to the motor.

Miss-alignment of the motor may lead to signal detection error, increasing internal friction or damage to the motor.

5. When external force is applied to the table, it is necessary to add the external force to the workload as the total carried load for the sizing.

When mounting cable duct and so on in parallel to the actuator, it is necessary to add the friction to the workload as the total carried load for the sizing too.

6. The resistance value of the attached equipment should be within the allowable external resistance value.

⚠ Caution

1. When using actuator with longer stroke, implement intermediate support to prevent frame deflection or deflection caused by vibration or external impacts. The spacing (l) of the intermediate supports must be no more than the values shown in the following graph.

If the actuator mounting surfaces are not measured accurately, using the intermediate support may cause poor operation. Make sure to level the mounting surface when mounting the actuator. For long stroke operation involving overhang of workpiece, implement intermediate support as recommended even if the support spacing is within the allowable limits shown in the graph. Use the support bracket (LEMB, LEMC) or the square nuts which are on the bottom of the actuator (LEMC, LEMH, LEMHT) for the intermediate support. The support bracket for LEMB, LEMC are not for mounting. They should be used only to provide support.

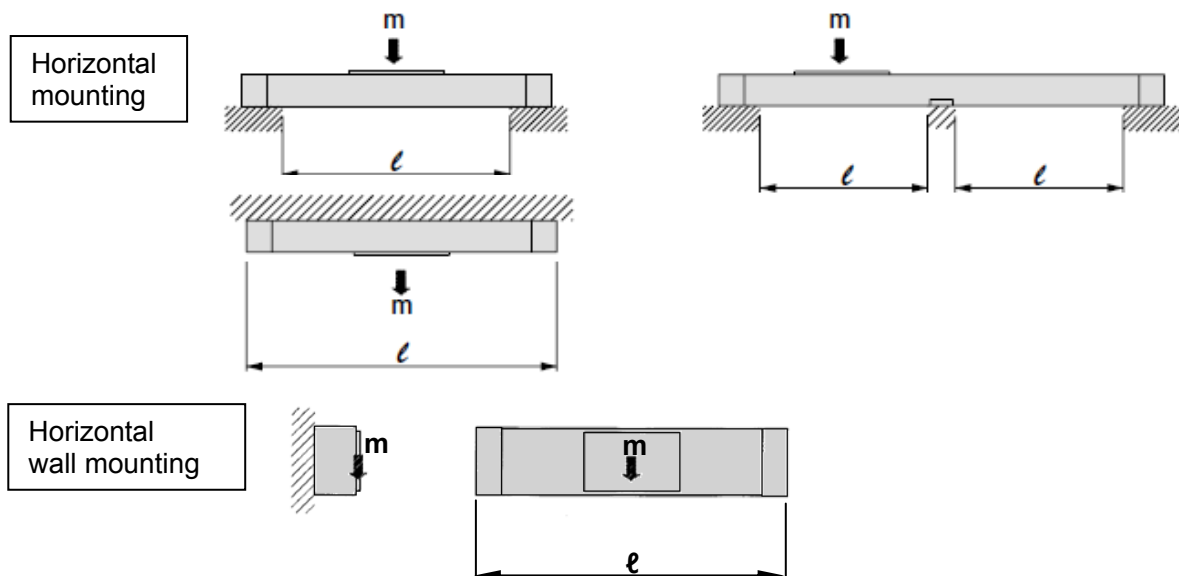

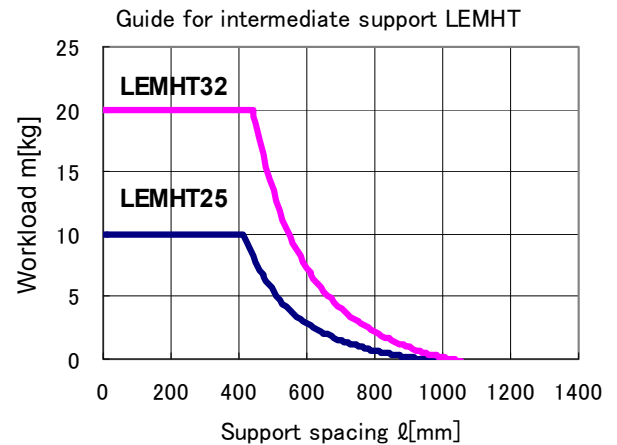
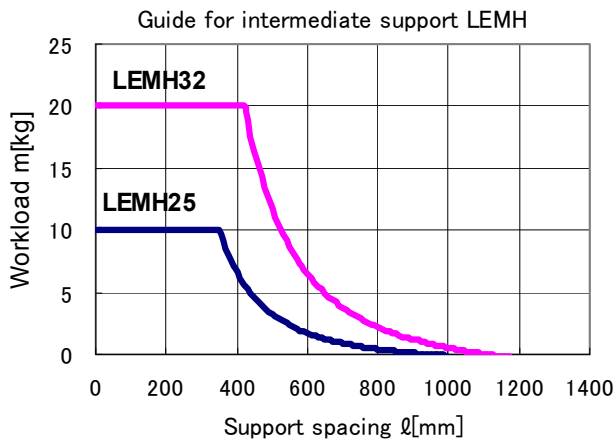
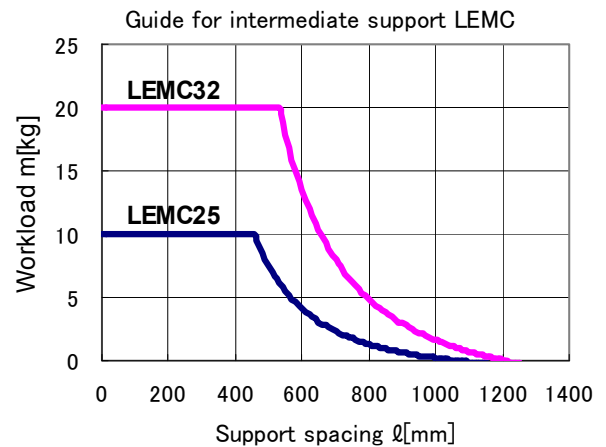
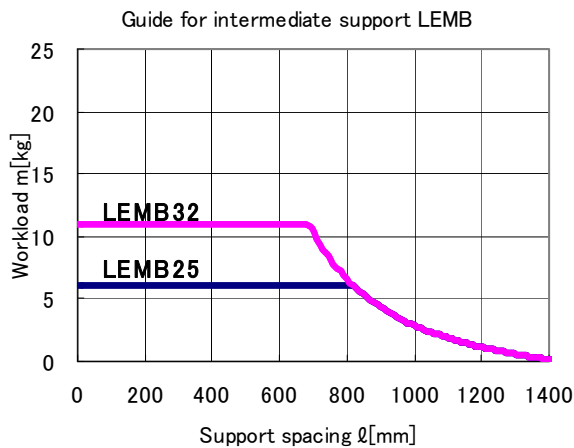

6.2 Handling



Caution

1. INP output signal

1) Positioning operation

When the product comes within the set range by step data [In position], output signal will be turned on. Set to [1] or higher for LEM.

2. Do not change the positioning force from initial setting.

If the positioning force is changed, it may cause a decrease in performance.

3. Do not operate by fixing the table and moving the actuator body.

An excessive load will be applied to the table, which could lead to damage to the actuator and reduced accuracy and reduced product life.

4. This actuator cannot be used for vertically mounted applications.

5. Check the specification for the minimum speed of each actuator.

6. In the case of the belt driven actuator, vibration may occur during operation at speeds within the actuator specification, this could be caused by the operating conditions. Change the speed setting to a speed that does not cause vibration.

7. Do not loosen or tighten the hexagon bolt which is on the stroke end side.

The adjusted belt tension using the hexagon bolt will be changed. It may lead faulty operation.

6.3 Mounting

⚠ Caution

1. **Provide a flat surface for installing the actuator. The degree of surface flatness should be determined by the machine precision requirement, or its corresponding precision.**

The degree of surface flatness for installing the actuator should be 0.1 / 500 mm. The degree of surface flatness for mounting a workpiece should be 0.05 mm (LEMB series), 0.02 mm (LEMC, LEMH, LEMHT series). Insufficient flatness of the work piece or the surface onto which the actuator body is to be mounted can cause play in the guide and increased sliding resistance.

2. **When mounting the workpiece or other device to the actuator tighten the fixing screws with adequate torque within the specified torque range.**

Tightening the screws with a higher torque than the maximum may cause malfunction, whilst tightening with a lower torque can cause the displacement of the mounting position or in extreme conditions detaching of the work piece.

Work piece mounting

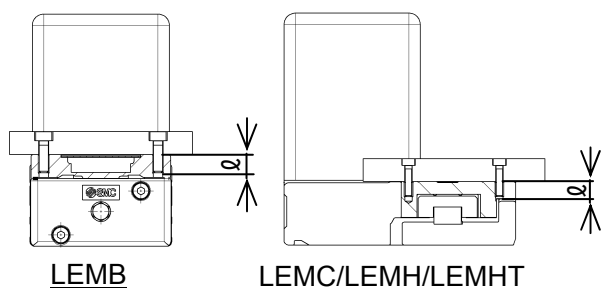

Model	Bolt size	Maximum tightening torque [Nm]	ℓ (Maximum thread depth [mm])
LEMB□	M5x0.8	3	8
LEMC25 LEMH25	M4x0.7	1.5	7
LEMC32 LEMH32	M5x0.8	3	9
LEMHT25	M5x0.8	3	9
LEMHT32	M8x1.25	12.5	12

Use screws with adequate length, but with length less than the maximum thread depth. The use of screws that are too long can touch the body and cause malfunction.

3. **Workpiece mounting**

When mounting a magnetic workpiece, keep a clearance of 5 mm or greater between the auto switch and the workpiece. Otherwise, the magnetic force within the actuator may be lost, resulting in malfunction of the auto switch.

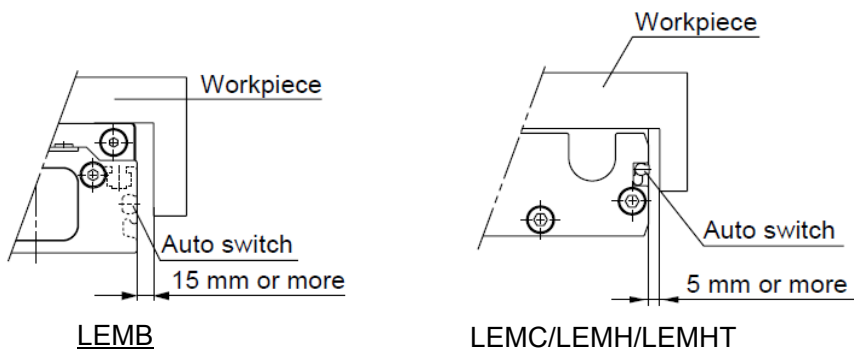

4. When mounting the actuator, use screws with adequate length and tighten them to the adequate torque. And use all mounting holes to maintain the catalogue performance.

Tightening the screws with a higher torque than recommended may cause malfunction, whilst the tightening with lower torque can cause the displacement of mounting position or in extreme conditions the actuator could become detached from its mounting position. Use 4 mounting holes on the top of the body or nuts inside 2 T slots on the bottom of the body for installation. Do not clamp the actuator body by using vise for mounting the actuator.

Installation of actuator (Using the mounting holes from the top)

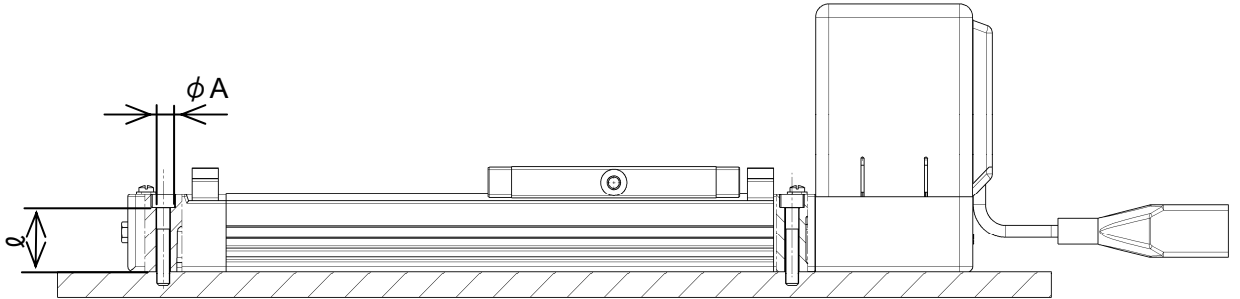

Model	Bolt size	φA (mm)	ℓ (mm)
LEMB□	M5	5.5	24.5
LEMC25 LEMH25	M3	3.4	23.7
LEMC32 LEMH32	M5	5.5	30.1
LEMHT25	M5	5.5	21.6
LEMHT32	M8	9	26.9

Installation of actuator (Using the nuts from the bottom)
(LEMC/LEMH/LEMHT)

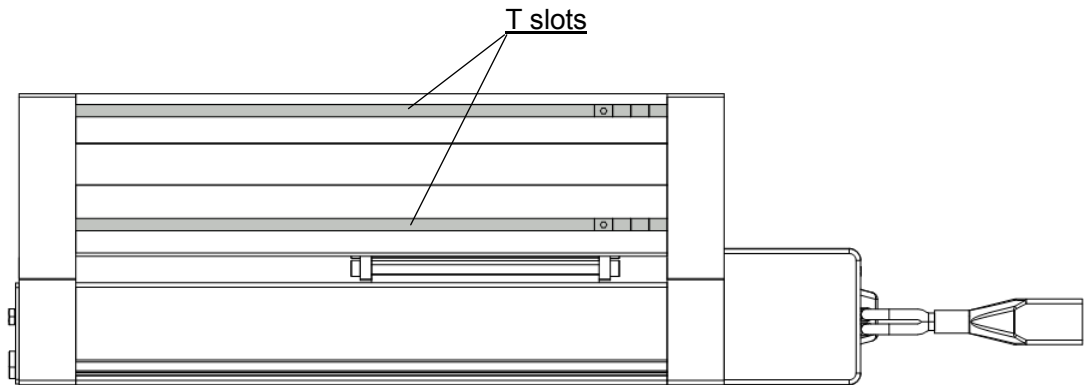

Model	Bolt size	Effective length (mm)
LEMC25 LEMH25	M3	4~5
LEMC32 LEMH32	M5	6~8
LEMHT25	M4	6~7
LEMHT32	M6	8~10

Note) If T slots on the bottom in used for installation, select screw which enables only effective length of it to enter from the bottom.

5. **When mounting the actuator, leave a gap of 40mm or more to allow for bending of the actuator cable.**
6. **Hold the body when handling**
The actuator could be damaged, resulting in its failure and or malfunction.
7. **Stroke adjustment**
Adjust the stroke of actuating part if necessary. (Stroke adjusting unit for LEMB is optional, please order separately if necessary.)
Loosen fixing bolt, move the unit to the position where required stroke is obtained and fix the unit by the bolt.

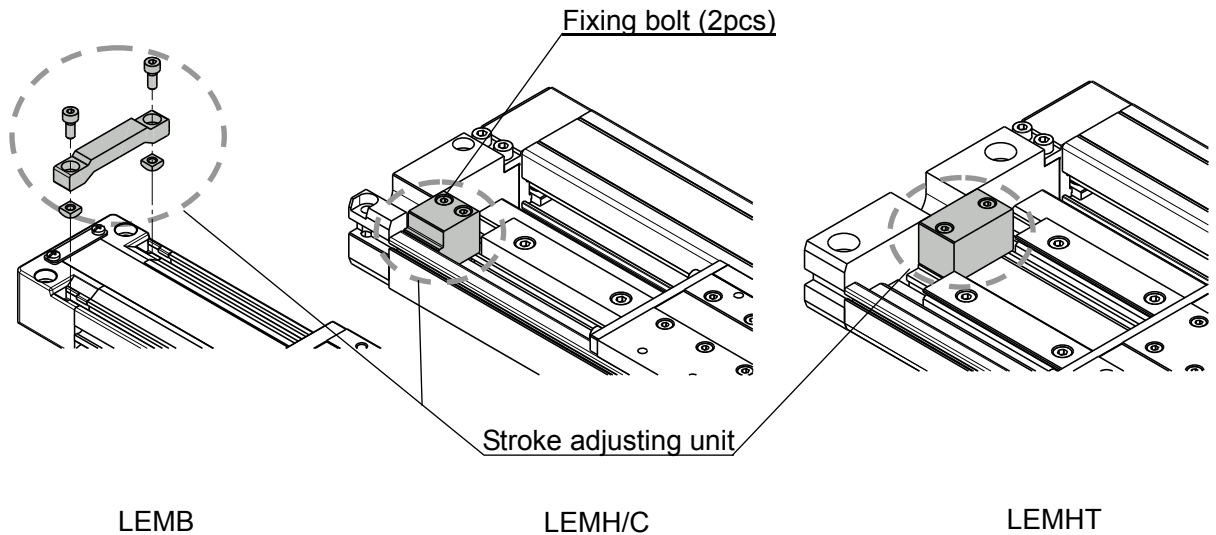

Model	Bolt size	Recommended tightening torque [Nm]
LEM B□	M4	1.5
LEM C/H/HT25	M3	0.63
LEM C/H/HT32	M4	1.5

6.4 Precaution on maintenance

Warning

1. Turn off the power supply before maintenance and replacement of the product.

[Maintenance frequency]

Perform maintenance according to the table below. Contact SMC if any abnormality is found.

Frequency	Appearance check	Internal check	Belt check
Inspection before daily operation	○	/	/
Inspection every six months / 1000km / 5million cycles *	○	○	○

*Whichever occurs first.

[Items for visual appearance check]

1. Loose screws. Abnormal dirt.
2. Check of flaws/faults and cable connections.
3. Vibration, noise.

[Items for internal check]

1. Lubricant condition on moving parts.
2. Loose or mechanical play in fixed parts or fixing screws.

[Items for belt check]

Check the belt regularly as shown in “maintenance frequency”.

Stop operation immediately and contact SMC when the belt appears to be like photographs shown below.

a. Tooth shape canvas is worn out

Canvas fiber becomes fuzzy.

Rubber is removed and the fiber becomes whitish.

Lines of fibers become unclear.



Teeth become fuzzy

b. Peeling off or wearing of the side of the belt

Belt corner becomes round and frayed thread sticks out.



c. Belt partially cut

Belt is partially cut. Foreign matter caught in teeth other than cut part causes flaw.

d. Vertical line of belt teeth

Flaw, which is made when the belt runs on the flange.

e. Rubber back of the belt is softened and sticky.

f. Crack on the back of the belt



2. Attaching and detaching the drive unit (LEM□ / LEMH / LEMHT)

To remove the drive unit, remove the 6 drive unit holding bolts and remove the slider from the guide unit. To install the drive unit, insert its slider into the slide table on the guide unit and tighten 2 bolts of connection part, ((1) shown in the figure below), and then equally tighten the 4 holding bolts, ((2) shown in the figure below). Tighten the holding bolts securely because if they become loose, problems may occur such as damage, malfunction, etc.

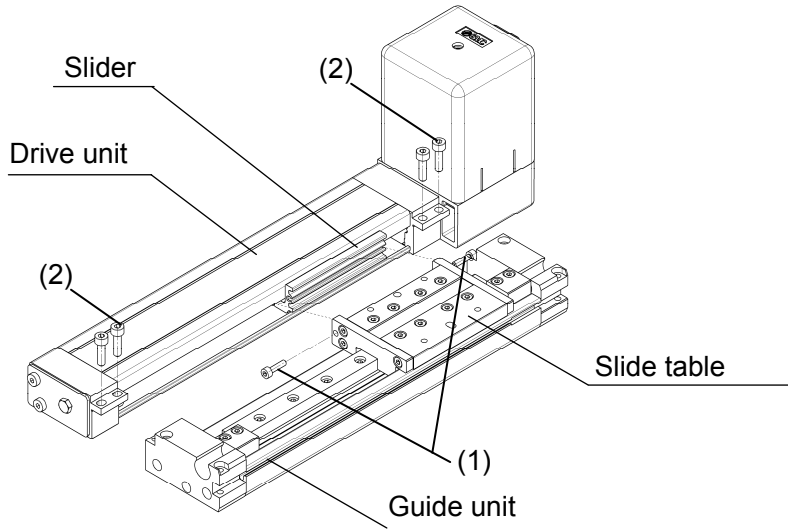

Model	Bolt size (Recommended tightening torque [Nm])	
	(1)	(2)
LEM□25	M3x12 (0.63)	M4x12 (1.5)
LEM□32	M4x12 (1.5)	M5x16 (3)

7. Trouble shooting

Alarms below are abstract of representative examples.

For other alarms, see operation manual of controller.

No.	Phenomenon	Cause	Countermeasure
1	Fail to operate / Initial stage	1) The cable is not connected or has been disconnected.	Check if the cable is properly installed / /See 4.Wiring of cable on page 30
	When power is supplied, alarm for "Phase Det ALM /code: 1-193" is generated. ↓ <Procedure of restart> "Turn the power supply off." ↓ "Turn the power supply on"	2) The load/resistance being applied to the actuator constantly exceeds the actuators specification	Keep load and resistance within specification range. Check the actuator mounting condition or check if external force adds the resistance of actuator table by using movable cable-duct. /See 2.1 Specifications on page 9
		3) The combination of the controller and actuator is not correct.	The controller and the actuator combination at the time of shipment should not be changed. /See 5.3 [△] Caution(1) on page 33
		4) Excessive external force is being applied, (including vibration) or impact load.	Operate within the specified range. /See 2.1 Specifications on page 9
		5) The flatness of work piece and the mounting surface exceeds the specified range.	Operate within the specified range. /See 2.1 Specifications on page 9
	Alarm for "Step data ALM1/code:1-048" is generated ↓ <Procedure of restart> Input the "RESET" signal.	Setting condition for step data is not correct. < Correct set condition > (1)Area 1 < Area 2	Review the content of step data. / Refer to the LEC controller operation manual.
	Alarm for "Servo off ALM/code: 1-098" is generated ↓ <Procedure of restart> Input the "RESET" signal.	Perform the "Return to origin", the positioning operation and JOG operation during the "SVON": OFF.	Provide the operation instruction after confirming that the input signal [SVON] is ON and then the output signal [SVRE] is ON.
	Alarm for "Drive ALM/code: 1-099" is generated. ↓ <Procedure of restart> Input the "RESET" signal.	Perform positioning operation before the "return to origin".	Provide the operation instruction after confirming that the input signal [SETUP] is ON and then the output signal [SETON] is ON.

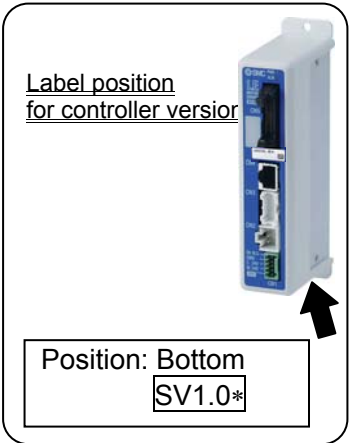
No.	Phenomenon	Cause	Countermeasure
2	<p>Operation not completed / Operation continue</p> <p>Alarm for "Over load/code: 1-148" or "Posn failed/code: 1-149" is generated.</p> <p style="text-align: center;">↓</p> <p style="text-align: center;"><Procedure of restart> Controller version /SV1.0 or later 1. Input the "reset signal." →"SVRE": Automatically ON</p> <div style="border: 1px solid black; padding: 5px; margin: 10px 0;"> <p><u>Label position for controller versior</u></p>  <p style="text-align: center;">Position: Bottom SV1.0*</p> </div>	1) Added excessive external force (including vibration) or impact load.	Operate within the specified range. /See 2.1 Specifications on page 9
		2) The Power supply does not have sufficient capacity.	Check the power consumption for each actuator and controller: If necessary replace the existing power supply with a power supply with sufficient capacity. /See 2.1 Specifications on page 9
		3) Load/resistance more than specified range is being applied to the actuator.	Use within specification range. Check the actuator mounting condition or check if external force adds the resistance of actuator table by using movable cable-duct. /See 2.1 Specifications on page 9
		4) Pushing operation is performed at "Positioning operation"	Review the content of the step data.
		5) The cable is not connected or has been disconnected.	Confirm that the cable is connected correctly. /See 4. Wiring of cable on page 30
		6) It was not the intended origin position because the actuator pinched the work-piece during the"return to origin".	Remove the work-piece and restart the return to the intended origin position.
		7) Actuator mouting condition is not good.	Check the actuator mounting surface. Keep the flatness of mounting surace to within 0.1 mm / 500mm or less.
		8) Wrong input [0] is input as the positioning force.	Check the step data.<Moving force> /See 3.3.Step data setting method on page 21
		9) The step data position is not changed correctly after the return to origin direction is changed.	Check the step data.<Position> /See 3.3.Step data setting method on page 21
		10) Because the operation of the step data is set to [INC/relative], the table comes into contact with an external object and does not move due to continuous operation.	Check the step data.<Position> /See 3.3.Step data setting method on page 21
1	<p>Operation not completed / Operation continue</p> <p>Alarm for "Stroke limit/code: 1-052" is generated.</p> <p style="text-align: center;">↓</p> <p style="text-align: center;"><Procedure of restart> Input the "RESET" signal.</p>	1) Moving distance exceeds the "Stroke (+)" / "Stroke (-).	1) Check the value of the "Position" of step data and the value of the "Stroke (+)" / "Stroke (-)" of the basic parameter. /See 3.3.Step data setting method on page 21 3.4.Parametertrting o sen page 27 /Refer to the LEC controller operation manual.

No.	Phenomenon	Cause	Countermeasure
2	<p>Operation not completed / Operation continue</p> <p>Alarm for "Over motor Vol /code: 1-145" is generated.</p> <p style="text-align: center;">↓</p> <p><Procedure of restart></p> <p>Controller version /SV1.0 or later</p> <p>1. Input the "reset signal." →"SVRE": Automatically ON</p> <div data-bbox="288 595 651 927" style="border: 1px solid black; padding: 5px; margin-top: 10px;"> <p><u>Label position for controller version</u></p>  <p>Position: Bottom SV1.0*</p> </div>	<p>1) If the power supply is an "inrush-current restraining type", the alarm may be generated due to voltage drop.</p>	<p>Replace the power supply with a non "inrush-current restraining type" power supply. / Refer to the LEC controller operation manual.</p>
		<p>2) The Power supply does not have sufficient capacity.</p>	<p>Check the power consumption for each actuator and controller: If necessary replace the existing power supply with a power supply with sufficient capacity. /See 2.1 Specifications on page 9</p>
		<p>3) Load/resistance more than specified range is being applied to the actuator.</p>	<p>Use within specification range. Check the actuator mounting condition or check if external force adds the resistance of actuator table by using movable cable-duct. /See 2.1 Specifications on page 9</p>

No.	Phenomenon	Cause	Countermeasure
2	Alarm for "Err overflow/code: 1-196" is generated. ↓ <Procedure of restart> "Turn the power supply off." ↓ "Turn the power supply on"	1) Added excessive external force (including vibration) or impact load.	Operate within the specified range. /See 2.1 Specifications on page 9
		2) The Power supply does not have sufficient capacity.	Check the power consumption for each actuator and controller: If necessary replace the existing power supply with a power supply with sufficient capacity. /See 2.1 Specifications on page 9
		3) Load/resistance more than specified range is being applied to the actuator.	Use within specification range. /See 2.1 Specifications on page 9 Check the actuator mounting condition or check if external force adds the resistance of actuator table by using movable cable-duct.
		4) The pushing operation is performed at the "Positioning operation position"	Review the content of the step data.
		5) The cable is not connected or has been disconnected.	Confirm that the cable is connected correctly. /See 4. Wiring of cable on page 30
		6) It was not the intended origin position because the actuator pinched the work-piece during the "return to origin".	Remove the work-piece and restart the return to the intended origin position.
		7) Wrong input [0] is input as the positioning force.	Check the step data. <Moving force> /See 3.3. Step data setting method on page 21
		8) The step data position is not changed correctly after the return to origin direction is changed.	Check the step data <Position>. /See 3.3. Step data setting method on page 21
		9) Because the operation of the step data is set to [INC/relative], the table comes into contact with an external object and does not move due to continuous operation.	Check the step data <Position>. /See 3.3 Step data setting method on page 21
		10) Actuator mouting condition is not good.	Check the actuator mounting surface. Keep the flatness of mounting surace to within 0.1 mm / 500mm or less.

No.	Phenomenon	Cause	Countermeasure
2	Operation not completed / During operation (Not always, but may happen occasionally) Alarm for "Step data ALM2/code: 1-051" is generated. ↓ <Procedure of restart> Input the "reset" signal.	1) Command invalid (unregistered) step data.	Check if the step data is valid (registered).
		2) Different input signal to the expected step number is inputted to the controller, because of a too short an interval between the input signal of "IN*" and the "Drive" or inputting the signals at the same time.	Add an interval of 15ms (the recommendation is 30ms) or more between the input signals. / See "Operating procedure input / output signals for each operation type" on page 25
		3) Different input signal to the expected step number is inputted to the controller, because the input signal time was too short.	Add an interval of 15ms (the recommendation is 30ms) or more between the input signals. / See "Operating procedure input / output signals for each operation type" on page 25
		4) Different input signal to the expected step number is inputted to the controller, caused by PLC or other device.	Check that the step number is inputted correctly for the required motion.

No.	Phenomenon	Cause	Countermeasure
2	- Operation completed by unexpected motion. - No alarm / During operation (Not always, but may happen occasionally)	1) Different input signal to the expected step number is inputted to the controller, because of a too short an interval between the input signal of the "IN*" and the "Drive" or inputting the signals at the same time.	Add an interval of 15ms (the recommendation is 30ms) or more between the input signals. / See "Operating procedure input / output signals for each operation type" on page 25 Note) Recommend to check the "OUT" output signal for more secure operation.
		2) Different input signal to the expected step number is inputted to the controller, because the input signal time was too short.	Add an interval of 15ms (the recommendation is 30ms) or more between the input signals. / See "Operating procedure input / output signals for each operation type" on page 25 Note) Recommend to check the "OUT" output signal for more secure operation.
		3) Different input signal to the expected step number is inputted to the controller, caused by PLC or other device.	Check that the step number is inputted correctly for the required motion. / See "Operating procedure input / output signals for each operation type" on page 25 Note) Recommend to check the "OUT" output signal for more secure operation.
		4) Actual stroke range is changed (in case of operating by LECP2), caused by stroke adjusting unit, external stopper or something.	Check the actual stroke range, and then command "Stroke study" again. / Refer to the LECP2 controller operation manual.

No.	Phenomenon	Cause	Countermeasure
3	"INP" output signal is unstable. "INP" output signal is unstable even after the positioning operation is completed.	1) The value of [In position] in step data is too small.	Increase [In position] value as the following. LEM: [1] or more
4	Positioning repeatability is out of specified range.	1) It shifts to the next operation by receiving the "INP" output signal.	Shift to the next operation after receiving the "BUSY" output signal is outputted.
		2) The belt is loosened.	Readjust belt tension to the appropriated value.
5	Damage	1) Abnormal external force	Interference of mechanism, eccentric load or excess load leads to cause deformation or damage of the actuator. Eliminate these factors.
6	The table of the actuator with vertical mounting vibrates repeated up and down.	1) Actuator is used vertically.	Actuator cannot be used vertically. Use actuator for horizontal and wall mounting only.
7	The belt driven actuator, vibration / noise occur during operation at speeds within the actuator specification.	1) Influence of character frequency	Change the speed setting to a speed that does not cause vibration.
		2) The gain tuning is not suitable.	It may need gain tuning suitable for the application. Contact SMC in this case.
8	Cannot be actuated manually or by manual override adjustment screw (does not operate). (At stop(EMG) or SVRE[OFF])	1) Contacts the stroke end of the actuator or the workpiece.	Check the stroke position and how workpieces are mounted.
		2) [Lock type] is selected	Supply 24VDC power supply to the [BK RLS] terminal of controller/CN1 power supply plug in order to unlock. /see 5.6 Precautions for the actuator with lock  Warning(6) on page 35
	Lock type is selected, but workpieces are dropped during stopping(EMG) or SVRE[OFF], or moved by external force.	1) Load exceeding the maximum work load is mounted, or external force more than the lock holding force is applied. 2) 24VDC is supplied to "BK RLS" terminal of controller/CN1 power supply connector.	Check the mounted load and lock holding force to confirm if they are within the operation range. /See 2.1 Specifications on page 9 Stop supplying 24VDC power supply to the [BK RLS] terminal /see 5.6 Precautions for the actuator with lock  Warning(8) on page 35

Revision history

No.LEM-OM00201

Mar. / 2013: 1st printing

No.LEM-OM00202

Mar/ 2013: Revision

SMC Corporation

4-14-1, Sotokanda, Chiyoda-ku, Tokyo 101-0021 JAPAN

Tel: + 81 3 5207 8249 Fax: +81 3 5298 5362

URL <http://www.smcworld.com>

Note: Specifications are subject to change without prior notice and any obligation on the part of the manufacturer.
© 2013 SMC Corporation All Rights Reserved