



Operation Manual

PRODUCT NAME

Magnetic Field Resistant 2-color Indication Type
Solid State Auto Switch

MODEL / Series / Product Number

D-P3DW(A) Series*

SMC Corporation



Contents

Safety Instructions	2
Model Indication Method	8
Names and Functions of products	8
Definition and terminology	9
Mounting and Installation	10
Installation	10
Maintenance	11
Troubleshooting	12
Specification	16
Specifications	16
Dimensions	17

Safety Instructions

These safety instructions are intended to prevent hazardous situations and/or equipment damage. These instructions indicate the level of potential hazard with the labels of "Caution", "Warning" or "Danger". They are all important notes for safety and must be followed in addition to International standards (ISO/IEC) *1) and other safety regulations.

- *1) ISO 4414: Pneumatic fluid power -- General rules relating to systems.
- ISO 4413: Hydraulic fluid power -- General rules relating to systems.
- IEC 60204-1: Safety of machinery -- Electrical equipment of machines. (Part 1: General requirements)
- ISO 10218-1992: Manipulating industrial robots -Safety.
- etc.

-  **Caution** : CAUTION indicates a hazard with a low level of risk which, if not avoided, could result in minor or moderate injury.
-  **Warning** : WARNING indicates a hazard with a medium level of risk which, if not avoided, could result in death or serious injury.
-  **Danger** : DANGER indicates a hazard with a high level of risk which, if not avoided, will result in death or serious injury.

Warning

- 1. The compatibility of the product is the responsibility of the person who designs the equipment or decides its specifications.**

Since the product specified here is used under various operating conditions, its compatibility with specific equipment must be decided by the person who designs the equipment or decides its specifications based on necessary analysis and test results. The expected performance and safety assurance of the equipment will be the responsibility of the person who has determined its compatibility with the product. This person should also continuously review all specifications of the product referring to its latest catalog information, with a view to giving due consideration to any possibility of equipment failure when configuring the equipment.
- 2. Only personnel with appropriate training should operate machinery and equipment.**

The product specified here may become unsafe if handled incorrectly. The assembly, operation and maintenance of machines or equipment including our products must be performed by an operator who is appropriately trained and experienced.
- 3. Do not service or attempt to remove product and machinery/equipment until safety is confirmed.**
 1. The inspection and maintenance of machinery/equipment should only be performed after measures to prevent falling or runaway of the driven objects have been confirmed.
 2. When the product is to be removed, confirm that the safety measures as mentioned above are implemented and the power from any appropriate source is cut, and read and understand the specific product precautions of all relevant products carefully.
 3. Before machinery/equipment is restarted, take measures to prevent unexpected operation and malfunction.
- 4. Contact SMC beforehand and take special consideration of safety measures if the product is to be used in any of the following conditions.**
 1. Conditions and environments outside of the given specifications, or use outdoors or in a place exposed to direct sunlight.
 2. Installation on equipment in conjunction with atomic energy, railways, air navigation, space, shipping, vehicles, military, medical treatment, combustion and recreation, or equipment in contact with food and beverages, emergency stop circuits, clutch and brake circuits in press applications, safety equipment or other applications unsuitable for the standard specifications described in the product catalog.
 3. An application which could have negative effects on people, property, or animals requiring special safety analysis.
 4. Use in an interlock circuit, which requires the provision of double interlock for possible failure by using a mechanical protective function, and periodical checks to confirm proper operation.

Caution

The product is provided for use in manufacturing industries.

The product herein described is basically provided for peaceful use in manufacturing industries. If considering using the product in other industries, consult SMC beforehand and exchange specifications or a contract if necessary.
If anything is unclear, contact your nearest sales branch.

Limited warranty and Disclaimer/Compliance Requirements

The product used is subject to the following "Limited warranty and Disclaimer" and "Compliance Requirements".

Read and accept them before using the product.

Limited warranty and Disclaimer

1. The warranty period of the product is 1 year in service or 1.5 years after the product is delivered, whichever is first. *2)

Also, the product may have specified durability, running distance or replacement parts. Please consult your nearest sales branch.

2. For any failure or damage reported within the warranty period which is clearly our responsibility, a replacement product or necessary parts will be provided.

This limited warranty applies only to our product independently, and not to any other damage incurred due to the failure of the product.

3. Prior to using SMC products, please read and understand the warranty terms and disclaimers noted in the specified catalog for the particular products.

*2) Vacuum pads are excluded from this 1 year warranty.

A vacuum pad is a consumable part, so it is warranted for a year after it is delivered.

Also, even within the warranty period, the wear of a product due to the use of the vacuum pad or failure due to the deterioration of rubber material are not covered by the limited warranty.

Compliance Requirements

1. The use of SMC products with production equipment for the manufacture of weapons of mass destruction (WMD) or any other weapon is strictly prohibited.

2. The exports of SMC products or technology from one country to another are governed by the relevant security laws and regulation of the countries involved in the transaction. Prior to the shipment of a SMC product to another country, assure that all local rules governing that export are known and followed.

Operator

- ◆ This operation manual is intended for those who have knowledge of machinery using pneumatic equipment, and have sufficient knowledge of assembly, operation and maintenance of such equipment. Only those persons are allowed to perform assembly, operation and maintenance.
- ◆ Read and understand this operation manual carefully before assembling, operating or providing maintenance to the product.

Warning

- Do not disassemble, modify (including changing the printed circuit board) or repair.
An injury or failure can result.
- Do not operate the product outside of the specifications.
Do not use for flammable or harmful fluids.
Fire, malfunction, or damage to the product can result.
Verify the specifications before use.
- Do not operate in an atmosphere containing flammable or explosive gases.
Fire or an explosion can result.
This product is not designed to be explosion proof.
- If using the product in an interlocking circuit:
 - Provide a double interlocking system, for example a mechanical system.
 - Check the product regularly for proper operation.
Otherwise malfunction can result, causing an accident.
- The following instructions must be followed during maintenance:
 - Turn off the power supply.
 - Stop the air supply, exhaust the residual pressure and verify that the air is released before performing maintenance work.
Otherwise an injury can be caused.

Caution

- Do not touch terminals and printed circuit board inside the product.
Otherwise it can cause electric shock, malfunction or damage to the product can result.
- After maintenance is complete, perform appropriate functional inspections.
Stop operation if the equipment does not function properly.
Safety cannot be assured in the case of unexpected malfunction.

NOTE

- Follow the instructions given below when designing, selecting and handling the product.
 - The instructions on design and selection (installation, wiring, environment, adjustment, operation, maintenance, etc.) described below must also be followed.
 - ◆ Product specifications
 - DC power supply to be used together must be UL 1310 class 2 power supply unit or UL recognized power supply with UL 1585 class 2 transformer.
 - Use the specified voltage.
Otherwise failure or malfunction can result.
 - Do not place two or more actuators close together.
When using two or more actuators closely in parallel, keep a distance of at least 40mm between the actuator tubes to prevent magnetic interference from affecting the product, which can cause malfunction.
(If the distance is specified for the actuator, use that value.)
 - Detection by an Auto switch mounted in a mid-stroke position depends on the piston speed. Conditions must satisfy the equation below.

Wherein;

Maximum detectable piston speed = V [mm/s]

$$V \text{ [mm/s]} = \frac{\text{Operating range of Auto switch [mm]}}{\text{Operating time of load [ms]}} \times 1000$$

- Design the product to prevent reverse current when the circuit is opened or the product is forced to operate for operational check.
Reverse current can cause malfunction or damage to the product.
- Reserve a space for maintenance.
Allow sufficient space for maintenance when designing the system.
- Product handling
 - ◆ Installation
 - Tighten to the specified tightening torque.
If the tightening torque is exceeded the mounting screws and brackets may be broken. If the tightening torque is insufficient, the product can be displaced.
(Refer to "Mounting and Installation".)
 - Be sure to ground terminal FG when using a commercially available switch-mode power supply.
 - Never mount an actuator equipped with Auto switch in a location that will be used as a foothold.
The product may be damaged if excessive force is applied by stepping or climbing onto it.
 - Do not drop, hit or apply excessive shock (over 1000 m/s²) to the Auto switch.
Otherwise damage to the internal parts can result, causing malfunction.
 - ◆ Cautions
 - Welding current
This product has no immunity against D.C. magnetic fields, so it is not suitable for use in applications where welding takes place using D.C. inverter/rectified source. If using in conjunction with a D.C. welding application, use it at a distance from the conductor, as with ordinary switches.
Rough guide for distance from conductor to prevent malfunction (10,000A: 30cm or more).
 - Effect of magnetization and demagnetization
In areas exceeding 10,000A, occasionally detection performance may become unstable due to demagnetization of the detection magnet (weakening of magnetic field) and magnetization of surrounding parts.

◆ Wiring

- Do not pull hard on the lead wire. In particular, never lift an Auto switch actuator by holding the lead wires.
Otherwise damage to the internal parts can result, causing malfunction.
- Avoid repeatedly bending or stretching the lead wire, or placing heavy load on them.
Repetitive bending stress or tensile stress can cause the sheath of the wire to peel off, or breakage of the wire.
If the lead wire can move, fix it near the body of the product.
The recommended bend radius is 40 to 80 mm. Contact SMC for details.
- Wire correctly.
Incorrect wiring can break the product.
- Do not perform wiring while the power is on.
Otherwise damage to the internal parts can result, causing malfunction.
- Do not route wires and cables together with power or high voltage cables.
Otherwise the product can malfunction due to interference of noise and surge voltage from power and high voltage cables to the signal line. Route the wires (piping) of the product separately from power or high voltage cables.
- Confirm proper insulation of wiring.
Poor insulation (interference from another circuit, poor insulation between terminals, etc.) can lead to excess voltage or current being applied to the product, causing damage.
- Design the system to prevent reverse current when the product is forced to operate for operational check.
Depending on the circuit used, insulation may not be maintained when operation is forced, allowing reverse current to flow, which can cause malfunction and damage the product.
- Keep wiring as short as possible to prevent interference from electromagnetic noise and surge voltage.
Do not use a cable longer than 100m.

◆ Environment

- Pay attention to use the product in an atmosphere with accumulation of iron waste or close contact with magnetic substances.
When a large amount of iron waste such as machining chips or spatter has accumulated, or a magnetic substance (something attracted by a magnet) is brought into close proximity with the actuator, it may cause the Auto switch to malfunction due to weakening.
- Do not use the product in an environment that is constantly exposed to the splash of water.
This can cause insulation failure or malfunction due to swelling of the potting resin.
- Do not use in a place where the product could be splashed by oil or chemicals.
If the product is to be used in an environment containing oils or chemicals such as coolant or cleaning solvent, even for a short time, it may be adversely affected. (insulation failure, malfunction due to swelling of the potting resin, or hardening of the potting resin, or hardening of the lead wires)
- Do not use the product in an environment where corrosive gases or fluids could be splashed.
Otherwise damage to the product and malfunction can result.
- Do not use in an area where surges are generated.
If there is equipment which generates a large amount of surge (solenoid type lifter, high frequency induction furnace, motor, etc.) close to the actuator, this may cause deterioration or breakage of the internal circuit of the Auto switch. Avoid sources of surge generation and crossed lines.
- Do not use a load which generates surge voltage.
When a surge-generating load such as a relay or solenoid is driven directly, use an Auto switch with a built-in surge absorbing element.
- The product is CE marked, but not immune to lightning strikes. Take measures against lightning strikes in the system.
- Mount the product in a place that is not exposed to vibration or impact (over 1000m/s²).
Otherwise failure or malfunction can result.

- Do not use the product in an environment that is exposed to temperature cycle.
Heat cycles other than ordinary changes in temperature can adversely affect the inside of the product.
- Do not expose the product to direct sunlight.
If using in a location directly exposed to sunlight, shade the product from the sunlight. Otherwise failure or malfunction can result.
- Keep within the specified ambient temperature range.
Otherwise malfunction can result.
- Do not operate close to a heat source, or in a location exposed to radiant heat.
Otherwise malfunction can result.

◆ Adjustment and Operation

- Adjust the Auto switch in the middle of the operating range and then fix it.
Adjust the position of the Auto switch so that the piston stops in the middle of the operating area (where Auto switch is in ON status).
Mounting the Auto switch close to the edge of the operating range can cause operation to be unstable.
- Turn the power on after connecting a load.
If switched on with no load, excess current may flow, causing the product to break instantly.

◆ Maintenance

- Turn off the power supply, stop the supplied air, exhaust the residual pressure and verify the release of air before performing maintenance.
There is a risk of unexpected malfunction.
- Perform regular maintenance and inspections.
There is a risk of unexpected malfunction.
- Do not touch the terminals while the power is on.
Otherwise malfunction and damage to the product can result.
- Do not use solvents such as benzene, thinner etc. to clean the Auto switch.
They could damage the surface of the body and erase the markings on the body.
Use a soft cloth to remove stains.
For heavy stains, use a cloth soaked with diluted neutral detergent and fully squeezed, then wipe up the stains again with a dry cloth.

◆ Other

- Contact SMC for information regarding water resistance, lead wire bend resistance.
- Contact SMC if there is a problem with the product's ON/OFF positions (hysteresis).

Hysteresis

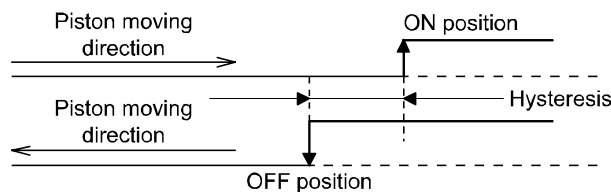

- There is larger current leakage than the existing models.
If the Auto switch is used as a replacement with the existing model, the input device and PLC cannot detect the Auto switch turning off.
<The OFF current of PLC is below the current leakage of the Auto switch [1mA]>
Ex.) PLC that cannot use a 2-wire type.
- The resin housing can be discolored due to the operating environment.
Due to the characteristics of the material used, the resin housing can be discolored by sunlight, but there is no effect in strength and other characteristics.

Model Indication Method

D - P 3 D W **A** **L**

• Ferromagnetic resistance

• Non-polarity

• 2-color indication

• Lead wire length

Symbol	Specification
Nil	500 mm
L	3000 mm
Z	5000 mm
SC	300 mm (M12 4 pin pre-wire: 3-4 pin)
SE	300 mm (M12 4 pin pre-wire: 1-4 pin)

• Symbol

Symbol	Specification
Nil	Special bracket necessary for round grooves.
A	Applicable to round grooves

Names and Functions of products

• Names of products

D-P3DW

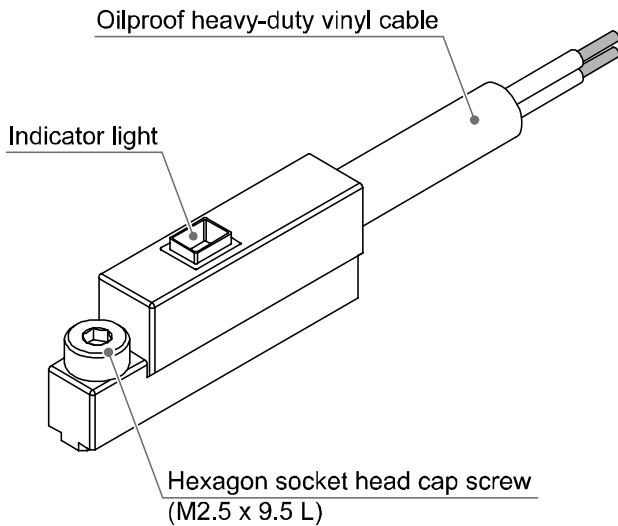

D-P3DWA

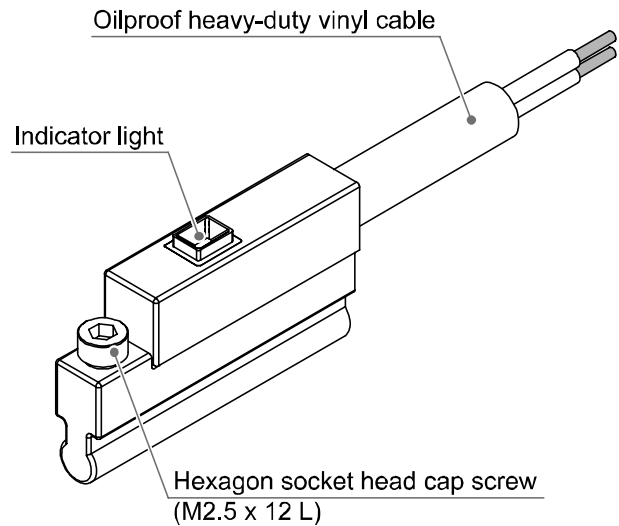

■ Definition and terminology

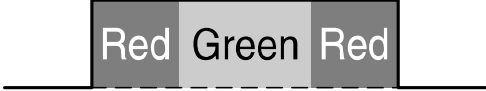
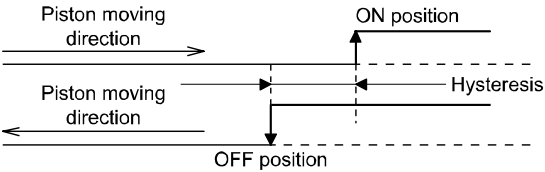
	Term	Meaning
2	2-color indication	<p>Display method in which a red LED turns on when it is in the operating position, and a green LED turns on when it is in the optimum operating range.</p> 
	2-wire Auto switch	Auto switch which has only signal line and COM line.
C	Current leakage	The current flowing to the load when the Auto switch turns off.
H	Hysteresis	<p>The difference between the points when the Auto switch turns on and off, which is provided to prevent chattering.</p> 
I	Internal voltage drop	The voltage applied between the COM and signal line when the Auto switch turns on.
L	Load current	The current flowing to the load when the Auto switch turns on.
M	Most sensitive position	The center position of the sensor unit (which gets the strongest reaction of the sensor unit), which means the center position of an operating range as well.
N	Non-polarity	A 2-wire type of connection which do not need care for polarity. Like 2-wire connection, it is necessary to put a load to either of (+) or (-).
S	Sequence controller (PLC)	The device to perform sequence control, which performs controlling such as receipt of inputs from the Auto switch along with programming and sending of the output to other machines.
	Solid state Auto switch	Auto switch which generates on and off outputs with or without mechanical contact such as a transistor.

Mounting and Installation

■ Installation

When mounting the Auto switch to actuator it should be done with a mounting bracket for actuator.

“How to mount” depends on the actuator type and tube I.D. Please refer the actuator catalogue.

When the Auto switch is newly mounted, please prepare the mounting bracket for actuator after confirming that the actuator has a built in magnet.

○ Precaution for Mounting

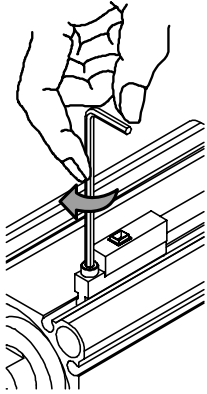

• Proper tightening torque

The tightening torque for a hexagon socket head cap screw (M2.5 x 12L) is 0.2 to 0.3N•m.

Hold the shorter side of a hexagon wrench, and turn it to tighten.

(Too much tightening may break the switch)

• Setting the detecting position

Set the actuator at the stroke end. Set the Auto switch in the area to where the Auto switch red lamp light is on.

(Detecting actuator end)

Based on A and B dimensions in the actuator catalogue, set the Auto switch.

For actual installation, perform adjustment by checking the operating conditions of the Auto switch.

Air grippers and rotary actuators have their own setting method. Follow their instructions.

• Internal circuit

D-P3DW(A)□

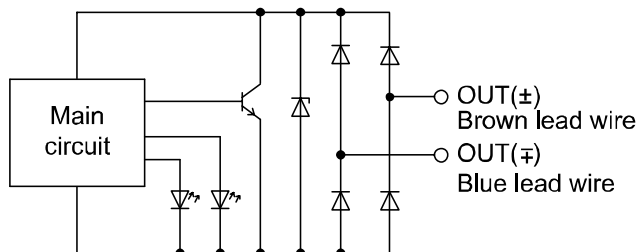

AND connection is not possible for this product.

D-P3DW(A)SC

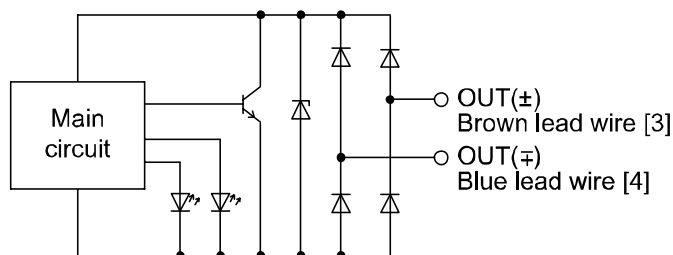

Connector pin assignment

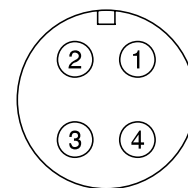

D-P3DW(A)SE

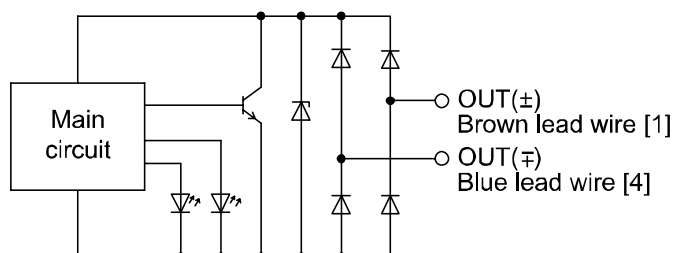

Maintenance

How to reset the product for power loss or forcible de-energizing

Regarding set up, contents of the program may be maintained by customer's application systems. Be sure to confirm safety when returning operation of the actuator because it could have been stopped in an unstable condition.

Troubleshooting

When the Auto switch in operation, identify the trouble with the following flow chart. A failure of the Auto switch might depend on the operating environment (application etc.) and needs to be given a test by contacting to us separately.

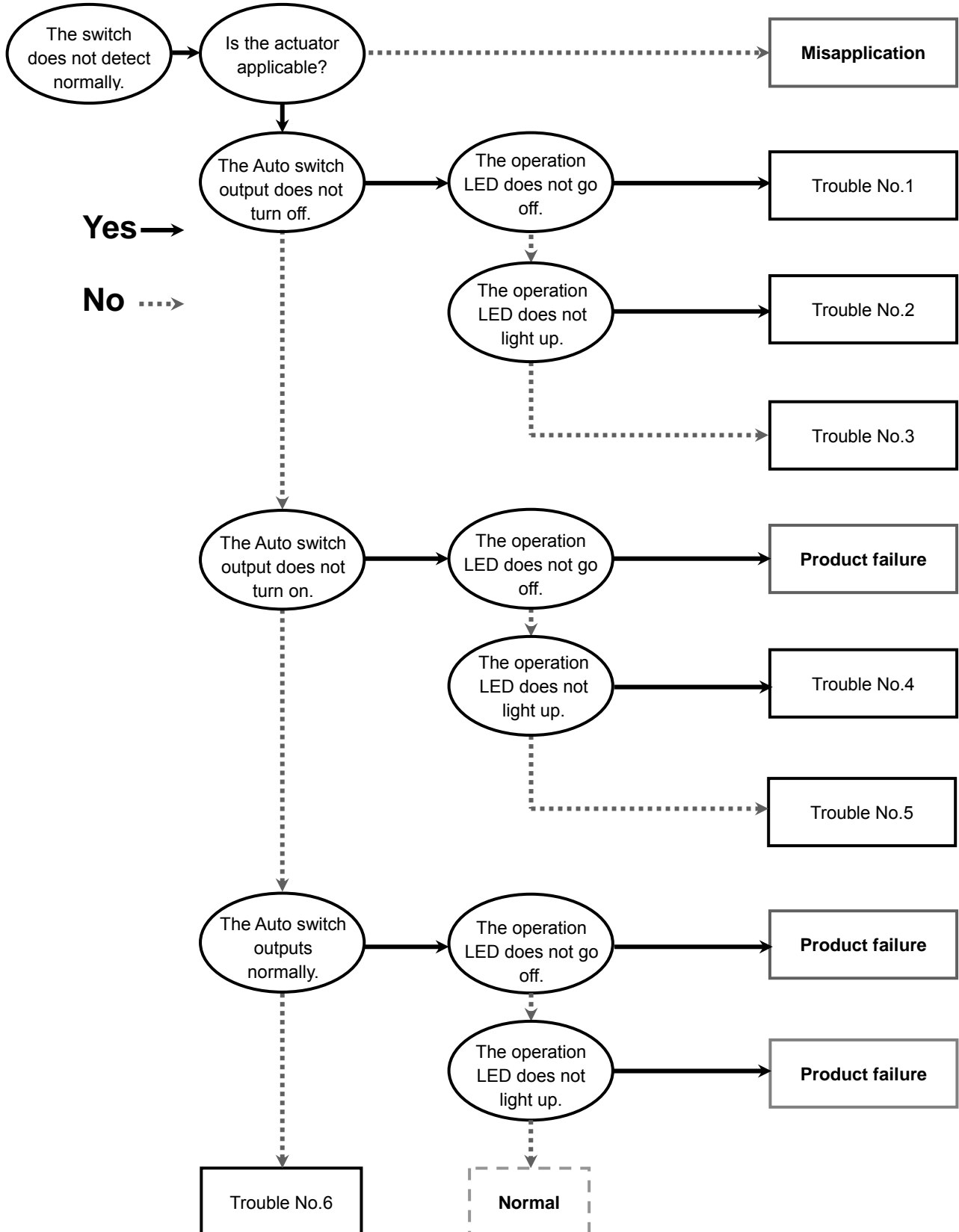

•Trouble list

Trouble No.	Trouble	Possible cause	Investigation to find possible cause	Countermeasure
1	The Auto switch output does not turn off.	Malfunction due to magnetic field	The effect of magnetic field generated by adjacent actuator	Place a magnetic shield plate to the actuator.
	The operation LED does not go off.	Improper setting (mounting) position *: Narrow angle	The presence of the following conditions - Auto switch operating angle - Actuator operating angle	Displace the Auto switch set position from the center of the actuator operating range.
2	The Auto switch output does not turn off. The operation LED does not light up.	Product failure	/	Replace the Product.
3	The Auto switch output does not turn off. The operation LED operates properly.	Mismatch of the load current specification (2-wire)	Satisfaction of the following relations by the load current specification Load voltage is "ON" level > (Current leakage x n) x load resistance or Load current is "OFF" level > (Current leakage x n) n: The number of parallel connecting Auto switches	Reduce the number of switches.

Trouble No.	Trouble	Possible cause	Investigation to find possible cause	Countermeasure
4	The Auto switch output does not turn on. The operation LED does not light up.	Power supply failure	Power supply voltage (zero or extremely low)	Adjust power supply voltage to a given value. (Refer to page 16 "Power supply voltage or Load voltage" in Specifications.)
		Incorrect wiring	Voltage (load) applied to the Auto switch	Correct wiring. (Refer to page 10 "Internal circuit".)
		Improper setting (mounting) position	Detection close to the limit of Auto switch operating angle	Move the Auto switch to proper position (near the center of the Auto switch operating angle).
		Displacement from set position	Looseness of the Auto switch unit or Auto switch mounting screw	Fix to proper position at the appropriate torque.
		Displacement of the actuator stopping angle	Deviation of the actuator stopping angle (position)	Stabilize stop position.
		Lowering of magnetic force for detection (demagnetization)	The presence of magnetic filed source near the actuator (electric welding machine conductor and strong magnet, etc.)	Place a magnetic shield plate between magnetic filed source and the actuator.
			The effect of magnetic field generated by adjacent actuator (placed within 20mm)	Separate the actuator (by 40mm or more). Place a magnetic shield plate.
			The presence of deposit of magnetic material (cutting chip) on the actuator	Remove the magnetic deposit.
Breakage of lead wire	The presence of repeated bending stress to a part of lead wire (bending radius, tensile force to the lead wire)	Correct wiring. (Adjust tensile force and enlarge bending radius.)		
5	The Auto switch output does not turn on. The operation LED operates properly.	Mismatch of the load current specification (2-wire)	Satisfaction of the following the load current specification Load voltage is "ON" level > Load voltage - (Internal voltage drop x n) n: The number of series connecting Auto switches	Reduce the number of switches.

Trouble No.	Trouble	Possible cause	Investigation to find possible cause	Countermeasure
6	The operation is unstable. (chattering)	Improper setting (mounting) position	Detection close to the limit of Auto switch operating angle	Move the Auto switch to proper position (near the center of the Auto switch operating angle).
		Displacement from set position	Looseness of the Auto switch unit or Auto switch mounting screw	Fix to proper position at the appropriate torque.
		Incorrect wiring	Condition of connected part (connector contact pin and crimping terminal)	Correct wiring. (Perform wiring of connected part again.)
		Breakage of lead wire	The presence of repeated bending stress to a part of lead wire (bending radius, tensile force to the lead wire)	Correct wiring. (Adjust tensile force and enlarge bending radius.)
		Malfunction due to magnetic field	The presence of a magnetic field source near the actuator (actuator, electric welding machine conductor, motor, magnet etc.)	Place a magnetic shield plate between magnetic field source and the actuator, or separate magnetic field source from the actuator. Mounting bracket, bolt, mounting frame, and tools are changed to non-magnetic materials.
	The Auto switch operates at multiple points.	Malfunction due to magnetic field	The effect of a magnetic field generated by adjacent actuator	Place a magnetic shield plate to the actuator.
	The load does not work.	Operating angle range detection at intermediate position	Satisfaction of the following relations by the actuator rotation speed Load operating time [s] < Auto switch operating angle range [mm]/Actuation operating speed [mm/s]	Decrease the actuating speed until specifications can be satisfied.

Specification

■ Specifications

Auto switch model	D-P3DW*
Wiring	2-wire
Output	-
Applicable load	24 VDC Relay / PLC
Load voltage	24 VDC (20 to 28 VDC)
Load current	6 to 40 mA
Internal voltage drop	5 V or less
Current leakage	1 mA or less
Operating time	40 ms or less
Indication light	Operating range: The red LED lights up. Proper operating range: The green LED lights up.
Electrical entry	Grommet
Lead wire	Vinyl sheath cable $\phi 4.8$, 0.5 mm ² , 2-wire
Impact proof	1000 m / s ²
Insulation resistance	50 M Ω or more under the test voltage 500 VDC (between case and cable)
Withstand voltage	1000 VAC 1min (between case and cable)
Ambient temperature	-10 to 60 °C
Enclosure	IEC60529 criteria IP67
Standards	CE, UL, RoHS

•Magnetic field resistance

When the alternative welding current is below 16000 A, it is not necessary to keep a distance between the actuator or Auto switch and the welding conductor (gun and cable). (Distance: 0mm) If the current exceeds 16000 A, check the distance between them.

■ Dimensions

D-P3DW(L)(Z)

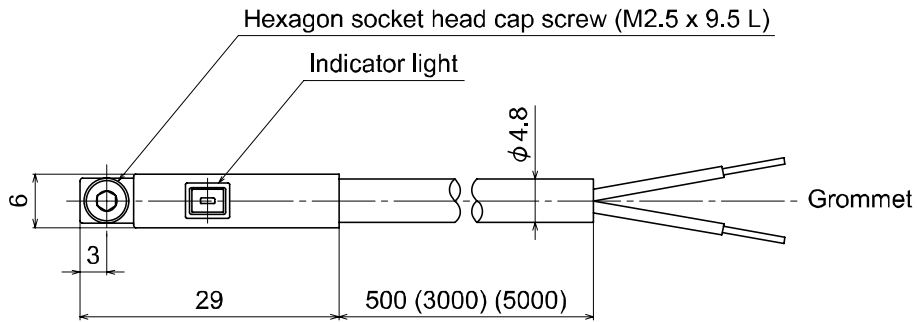

D-P3DWSC, P3DWSE

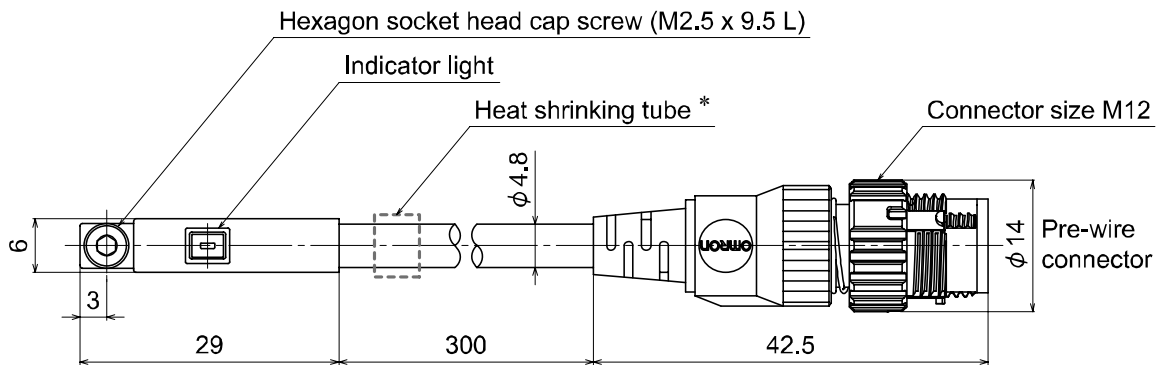

Common

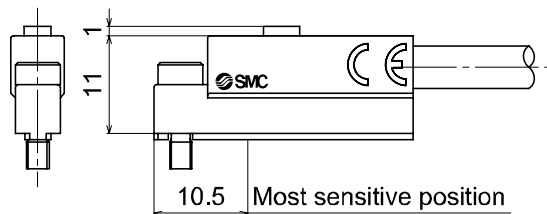

*: Mounting the white heat shrinking tube with only D-P3DWSE.

D-P3DWA(L)(Z)

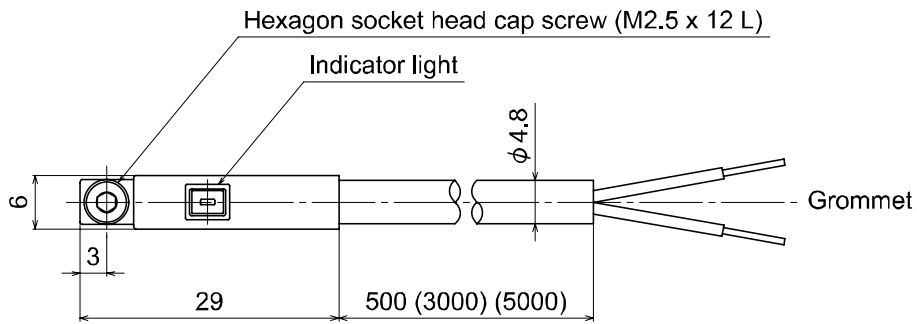

D-P3DWASC, P3DWASE

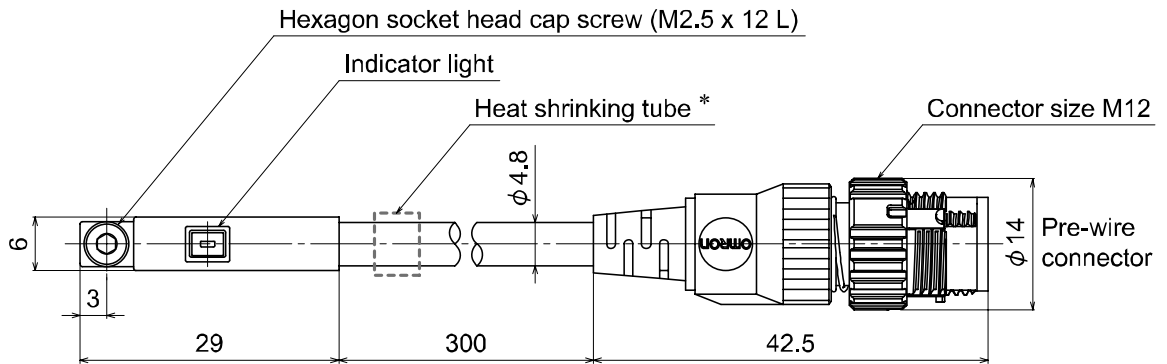

Common

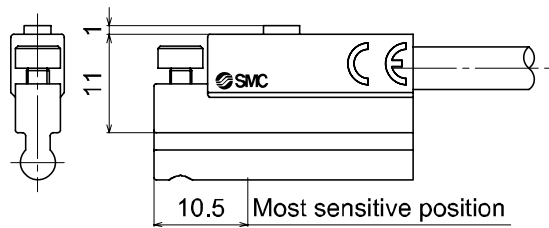

*: Mounting the white heat shrinking tube with only D-P3DWASE.

Revision history

A: Housing, thread and connector changed.
B: Addition of D-P3DWA

SMC Corporation

4-14-1, Sotokanda, Chiyoda-ku, Tokyo 101-0021 JAPAN
Tel: +81 3 5207 8249 Fax: +81 3 5298 5362
URL <http://www.smcworld.com>

Note: Specifications are subject to change without prior notice and any obligation on the part of the manufacturer.
© 2012 SMC Corporation All Rights Reserved

