



Brake Position Determination System's Operation Manual

PRODUCT NAME

*MONOSASHI-KUN WITH BRAKE
CONTROLLER*

MODEL / Series / Product Number

CE2
CEU2

SMC Corporation

Contents

Safety Instructions	1
1. General	8
1-1. Features	
1-2. Position Control	
1-3. Positioning at Stroke End	
2. System Configuration	9
2-1. System Checking Flow Chart	
2-2. System Configuration	
2-3. Recommended Circuit Design	
3. Specifications	14
3-1. Cylinder Specifications	
3-2. Controller Specifications	
3-3. Sensor Specifications	
4. Model	16
4-1. Cylinder	
4-2. Controller	
4-3. Extension Cable	
5. External Dimension Drawing	18
5-1. Monosashi-kun with Brake	
5-2. Controller	
5-3. Extension Cable	
6. Part Identification	22
6-1. Monosashi-kun with brake	
6-2. Controller	
7. Installation & Wiring	23
7-1. Installation	
7-1-1 Installation of Cylinder	
7-1-2 Installation of Controller	
7-2. Wiring	
7-2-1 The connection of Power Supply	
7-2-2 The connection of Extension Cable	
7-3. Input Signal's Wiring	
7-3-1 Input Signal Wiring Diagram	
7-3-2 Input Signal Content	
7-3-3 Input Signal Wiring	
7-3-4 OUTPUT Signal Wiring	
7-3-5 Solenoid Valve Wiring	
7-3-6 Sequencer	
8. Timing Chart	29
9. Data Setting	37
9-1. Preset Data Setting	
9-1-1 Data Classification & Content	
9-1-2 Input Method	
9-1-3 Confirmation of Set Data	

9-2. Program Setting	
9-2-1 Input Method	
9-2-2 Confirmation of Input Data	
9-3. Selection of Dip Switch	
10. Driving.....	45
10-1. Setting of Origin Direction	
10-2. Adjustment of Air Balance	
11. Error Messages & Countermeasures	46
11-1. Controller	
11-2. Brake Unit's Life Span	
12. Appendix.....	50
12-1. Data Sheet	

Specifications are subject to change without prior notice



CE2/CEU2 MONOSASHI-KUN WITH BRAKE/CONTROLLER Safety Instructions

These safety instructions are intended to prevent hazardous situations and/or equipment damage. These instructions indicate the level of potential hazard with the labels of "Caution," "Warning" or "Danger." They are all important notes for safety and must be followed in addition to International Standards (ISO/IEC)*1), and other safety regulations.

*1) ISO 4414: Pneumatic fluid power -- General rules relating to systems.

ISO 4413: Hydraulic fluid power -- General rules relating to systems.

IEC 60204-1: Safety of machinery -- Electrical equipment of machines .(Part 1: General requirements)

ISO 10218: Manipulating industrial robots -Safety.

etc.



Caution

Caution indicates a hazard with a low level of risk which, if not avoided, could result in minor or moderate injury.



Warning

Warning indicates a hazard with a medium level of risk which, if not avoided, could result in death or serious injury.



Danger

Danger indicates a hazard with a high level of risk which, if not avoided, will result in death or serious injury.

Warning

1. The compatibility of the product is the responsibility of the person who designs the equipment or decides its specifications.

Since the product specified here is used under various operating conditions, its compatibility with specific equipment must be decided by the person who designs the equipment or decides its specifications based on necessary analysis and test results.

The expected performance and safety assurance of the equipment will be the responsibility of the person who has determined its compatibility with the product.

This person should also continuously review all specifications of the product referring to its latest catalog information, with a view to giving due consideration to any possibility of equipment failure when configuring the equipment.

2. Only personnel with appropriate training should operate machinery and equipment.

The product specified here may become unsafe if handled incorrectly.

The assembly, operation and maintenance of machines or equipment including our products must be performed by an operator who is appropriately trained and experienced.

3. Do not service or attempt to remove product and machinery/equipment until safety is confirmed.

1. The inspection and maintenance of machinery/equipment should only be performed after measures to prevent falling or runaway of the driven objects have been confirmed.

2. When the product is to be removed, confirm that the safety measures as mentioned above are implemented and the power from any appropriate source is cut, and read and understand the specific product precautions of all relevant products carefully.

3. Before machinery/equipment is restarted, take measures to prevent unexpected operation and malfunction.

4. Contact SMC beforehand and take special consideration of safety measures if the product is to be used in any of the following conditions.

1. Conditions and environments outside of the given specifications, or use outdoors or in a place exposed to direct sunlight.

2. Installation on equipment in conjunction with atomic energy, railways, air navigation, space, shipping, vehicles, military, medical treatment, combustion and recreation, or equipment in contact with food and beverages, emergency stop circuits, clutch and brake circuits in press applications, safety equipment or other applications unsuitable for the standard specifications described in the product catalog.

3. An application which could have negative effects on people, property, or animals requiring special safety analysis.

4. Use in an interlock circuit, which requires the provision of double interlock for possible failure by using a mechanical protective function, and periodical checks to confirm proper operation.



CE2/CEU2 MONOSASHI-KUN WITH BRAKE/CONTROLLER Safety Instructions

Caution

1. The product is provided for use in manufacturing industries.

The product herein described is basically provided for peaceful use in manufacturing industries.

If considering using the product in other industries, consult SMC beforehand and exchange specifications or a contract if necessary.

If anything is unclear, contact your nearest sales branch.

Limited warranty and Disclaimer/Compliance Requirements

The product used is subject to the following "Limited warranty and Disclaimer" and "Compliance Requirements".

Read and accept them before using the product.

Limited warranty and Disclaimer

1. The warranty period of the product is 1 year in service or 1.5 years after the product is delivered, whichever is first.*2)

Also, the product may have specified durability, running distance or replacement parts. Please consult your nearest sales branch.

2. For any failure or damage reported within the warranty period which is clearly our responsibility, a replacement product or necessary parts will be provided.

This limited warranty applies only to our product independently, and not to any other damage incurred due to the failure of the product.

3. Prior to using SMC products, please read and understand the warranty terms and disclaimers noted in the specified catalog for the particular products.

***2) Vacuum pads are excluded from this 1 year warranty.**

A vacuum pad is a consumable part, so it is warranted for a year after it is delivered.

Also, even within the warranty period, the wear of a product due to the use of the vacuum pad or failure due to the deterioration of rubber material are not covered by the limited warranty.

Compliance Requirements

1. The use of SMC products with production equipment for the manufacture of weapons of mass destruction(WMD) or any other weapon is strictly prohibited.

2. The exports of SMC products or technology from one country to another are governed by the relevant security laws and regulation of the countries involved in the transaction. Prior to the shipment of a SMC product to another country, assure that all local rules governing that export are known and followed.

Caution

SMC products are not intended for use as instruments for legal metrology.

Measurement instruments that SMC manufactures or sells have not been qualified by type approval tests relevant to the metrology (measurement) laws of each country.

Therefore, SMC products cannot be used for business or certification ordained by the metrology (measurement) laws of each country.

Operating and Storage Environments

Warning

1. Environments to avoid

Avoid using or storing the products in the following environments which may cause failures.

If the products need to be used or stored in those environments, take necessary measures.

- a. Place where ambient temperature exceeds the range of 0°C to 60°C.
- b. Place where ambient humidity exceeds the range of 25% to 85% RH.
- c. Place where condensation occurs due to sudden temperature change.
- d. Place where atmosphere containing corrosive gas, flammable gas or organic solvent.
- e. Place where atmosphere containing con-ductive powder such as dust and iron chips, oil mist, salt, or organic solvent, or splashing cutting chips, dust and cutting oil (water , liquid) over the products.
- f. Place where the products are exposed to direct sunlight or radiated heat.
- g. Place where strong electromagnetic noise is generated (place where strong electric field, strong magnetic field or surge is generated).
- h. Place where static electricity is discharged or condition that the products have electrostatic discharge.
- i. Place where strong high frequency is gene-rated.
- j. Place where damages of thunder are expected.
- k. Place where vibration or impact is directly given to the products.
- l. Condition that the products are deformed by force or weight applied.

2. Do not close any objects which are affected by magnets.

Since magnets are built in cylinders, do not close magnetic disks, magnetic cards or magnetic tapes. The data may be destroyed.

Precaution on Design

Warning

1. There is a possibility of dangerous sudden action by cylinders if sliding parts of machi-nergy are twisted due to external forces, etc.

In such cases, human injury may occur; e. g., by

catching hands or feet in the machinery, or damage to the machinery itself may occur.

2. Provide a cover to minimize the risk of human injury.

When a driven object or moving parts of a cylinder may cause the risk of human injury, design a structure to avoid contact with human body.

3. Securely tighten all stationary parts and connected parts of cylinders so that they will not become loose.

Tighten cylinders securely especially when they are used in high frequency or in locations where direct vibration or impact shock, etc. will be applied to the body of the cylinder.

4. Deceleration circuits or shock absorbers are needed in some cases.

If a driven object travels at a high speed or is heavy, impact will not be sufficiently absorbed only with the cylinder cushion. In such cases, use a circuit to decelerate the cylinder speed before the cushion becomes effective or use external shock absorbers to reduce impact. At this time, take the rigidity of machinery into account.

5. Consider possible drop of pressure in circuit due to power outage.

For cylinders used in clamping mechanism, a work may become loose due to less clamping force by pressure drop in circuit at the time of power outage. Install safety devices to prevent human injury and machinery damage. Measures should be taken to prevent drop of hanging or lifting equipment.

6. Consider possible loss of power sources.

Measures should be taken to protect against human injury and machinery damage in the event that there is a loss of air pressure, electricity or hydraulic power.

7. Design circuit to prevent shooting out of a driven object.

A driven object is quickly shot out when pressure is supplied from one side of the piston after air in the cylinder is exhausted in such cases that cylinder is actuated by exhaust center type of directional control valve or started after residual air is exhausted from the circuit. At this time, human injury may occur; e.g., by catching hands or feet in the machinery, or damage to the machinery itself may occur. Therefore, the machine should be designed and constructed to prevent shooting out.

8. Consider emergency stops.

Design the machinery so that human injury and/or damage to machinery and equipment will not be caused when machinery is stopped by a safety device under abnormal conditions, a power outage or a manual emergency stop.

9. Consider actions when operation is restarted after an emergency stop or abnormal stop.

Design the machinery so that human injury or equipment damage will not occur upon restart of operation. When the cylinder is required to return to the initial position, provide the equipment with a safe override.

10. Construct the machinery so that moving objects and the moving parts of the cylinder with brake do not come into direct contact with the human body.

11. Use a balanced circuit in which lurching of the cylinder is prevented. When operation is locked in specified intermediate positions of the stroke, and air pressure is applied to only one side of the cylinder, the piston will lurch when the lock is released. This might cause injury or damage to machinery.

Selection

Warning

1. Confirm the specifications.

The product in this manual is designed to be used only in industrial compressed air system. The product should not be used with pressures or temperatures outside the range of the specifications, as this may cause damage or malfunction, etc.

2. Intermediate stop

When cylinder piston is stopped intermediately by 3-position closed center type of directional control valve, intermediate stop positions may not be as precise and exact as hydraulic operation due to compressibility of air. Valves and cylinders are not guaranteed for zero air leakage, and stop position may not be held in a long period of time. Consult SMC for long term holding of stop positions.

3. When a cylinder is in a no-load and locked state, the holding force (maximum static load) is the lock's ability to hold a static load that does not involve vibrations or shocks. To ensure braking force, the maximum load must be set as described below.

- ① For constant static loads, such as for drop prevention:

35% or less of holding force (Maximum static load)

Note) For applications such as drop prevention, consider situations in which the air source is shut off, and make selections based on the holding force of the spring locked state. Do not use the pneumatic lock for drop prevention purposes.

② When kinetic energy acts upon the cylinder, such as when effecting an intermediate stop, there are constraints in terms of the allowable kinetic energy that can be applied to the cylinder in a locked state. Refer to the allowable kinetic energy of the respective series. Furthermore, during locking, the mechanism must sustain the thrust of the cylinder itself, in addition to absorbing the kinetic energy. Therefore, even within a given allowable kinetic energy level, there is an upper limit to the amount of the load that can be sustained.

- Maximum load for horizontal mounting: 70% or less of the holding force (Maximum static load) for spring lock

- Maximum load for vertical mounting: 35% or less of the holding force (Maximum static load) for spring lock

③ In a locked state, do not apply impact, strong vibrations or rotational forces. Any impact, strong vibrations or rotational forces from external sources could damage or shorten the life of the lock unit.

④ Although the cylinder can be locked in both directions, be aware that its holding force is smaller in one of the directions. Holding force at piston rod extended side is approx. 15% less.

Caution

1. Mount speed controller and adjust cylinder operation speed gradually from low speed to a desired speed.

Air Supply

Warning

1. Do not use the product out of the specified ranges for pressure and temperature to prevent equipment damage and mal-function.

①Operating pressure:

Actuating part: 0.1 – 1.0MPa

Braking part: 0.3 – 0.5MPa

②Fluid & ambient temperature: 0 to 60°C

2. Use clean air.

Do not use the product with compressed air includes chemicals, synthetic materials (including organic solvents), salinity, corrosive gases, etc., as this may cause damage or malfunction.

Caution

1. Install air filter.

Install air filter before and in vicinity of valve. The filter should be able to collect particles of 5 microns or smaller. A large quantity of drain may cause malfunction of pneumatic components.

2. Install after cooler, air dryer, auto drain, etc.

Compressed air that includes excessive condensate may cause malfunction of valve and other pneumatic equipment. To prevent this, install after cooler, air dryer, auto drain, etc.

Pneumatic circuit

Warning

1. Be certain to use a pneumatic circuit which will apply balanced pressure to both sides of the piston when in a locked stop. (Refer to Chapter 6 for recommended pneumatic circuit.)

In order to prevent the cylinder lurching after a locked stop, use a circuit which applies balanced pressure to both sides of the piston when restarting or when manually releasing the lock, thereby canceling the force generated by the load in the direction of piston movement.

2. Use a solenoid valve for unlocking which has a larger effective area, as a rule 50% or more of the effective area of the cylinder drive solenoid valve. (Refer to Chapter 6 for recommended pneumatic components.)

The larger the effective area is, the shorter the locking time will be, and stopping accuracy will be improved.

3. Place the solenoid for unlocking close to the cylinder, and no farther than the cylinder drive solenoid valve.

The shorter the distance from the cylinder, the shorter the overrun amount will be, and stopping accuracy will be improved.

4. Allow at least 0.5 seconds from a locked stop (intermediate stop of the cylinder) until release of

the lock.

When the locked stop time is too short, the piston rod may lurch at a speed greater than the control speed of the speed controller.

5. When restarting, control the switching signal for the unlocking solenoid valve so that it acts before or at the same time as the cylinder drive solenoid valve.

If the signal is delayed, the piston rod may lurch at a speed greater than the control speed of the speed controller.

Installation

Warning

1. Connect the rod end and the load with the lock released.
2. **Ensure that the equipment operates properly before the use.**
3. **Operation manual**
Do not install the products unless the safety instruction have been read and understood. Keep this operation manual on file for future reference.

Caution

1. **Maintenance space**
When installing the products, allow space for maintenance.
2. **Installation of jigs**
When hardware and nuts are screwed into the piston rod end, the piston rod should be fully retracted.
Use double nuts to fix a work since Precision MONOSASHI-KUN (Scale Reading Cylinder) does not have any parallel parts at the rod.
3. **Do not give strong impact and/or excessive moment when work is mounted.**
External force other than allowable moment may cause rattle at guide part and/or increase in sliding resistance.
4. **Use the product in such a condition that load is always applied in the axial direction of the piston rod.**
When load is applied in other directions than cylinder axial direction, regulate the load itself by the guide.
Perform a complete centering when cylinder is mounted.
5. Be careful to avoid scratches or dents, etc. on the sliding sections of the piston rod.

Wiring

Warning

1. Preparation for wiring

Shut off the power before wiring (including insertion and removal of connectors). Mount a protective cover on the terminal block after wiring.

2. Check the power

Make sure the power has sufficient capacity and voltages are within the specified range before wiring.

3. Grounding

Ground terminal block F.G. (Frame Ground). Do not ground it with devices generating strong electromagnetic noise.

4. Check wiring

Incorrect wiring may cause damage or malfunction of the products. Make sure the wiring is correct before operation.

Caution

1. Separation of signal wires from power wire

Avoid common or parallel wiring of signal and power wires to prevent malfunction due to noise.

2. Wiring arrangement and fixation

Avoid bending cables sharply at connector part or electrical entry in wiring arrangement. Improper arrangement may cause disconnection which in turn causes malfunction. Fix cables close enough not to give excessive force to the connector.

Piping

Caution

1. Before piping

Remove cutting chips, cutting oil, dust, etc. in piping by flushing or cleaning before piping. Care should be taken especially that any cutting chips, cutting oil, dust, etc. do not exist after a filter.

2. At piping

- ① Foreign matter should not enter. Entering of foreign matter will cause malfunction.
- ② Cutting chips and sealing materials at piping threads should not enter valves when piping and fittings are screwed in. Leave 1.5 to 2 threads when seal tape is used.

Lubrication

Caution

1. Lubrication of cylinder

- ① This cylinder is pre-lubricated and can be used without lubrication.
- ② In case of lubrication, use a equivalent of the turbine oil type 1 ISO VG32. Once lubrication is performed, it should be continued since the initial lubricant flows out causing malfunction.

Adjustment

Caution

1. The locks are manually disengaged when the cylinder is shipped from the factory. Be sure to change them to the locked state before using the cylinder.
2. Adjust the cylinder's air balance. In the state in which a load is attached to the cylinder, disengage the lock and adjust the air pressure on the rod side and the head side of the cylinder to obtain a load balance. By maintaining a proper air balance, the piston rod can be prevented from lurching when the lock is disengaged.
3. Adjust the mounting position of detection devices such as autoswitches.

Sensor unit

Caution

1. Do not remove the sensor unit.
The position and sensitivity of the sensor is adjusted properly before shipment.
Removing or replacing the sensor may cause malfunction.
2. Operate the system with an external magnetic field of 14.5mT or less.
Strong magnetic field in the vicinity may cause malfunction, since CE2 sensor is magnetic type. This is equivalent to a magnetic field of approximately 18cm in radius from a welding area using a welding current of almost 15,000 amperes. To use the system in a magnetic field that exceeds this value, use a magnetic material to shield the sensor unit

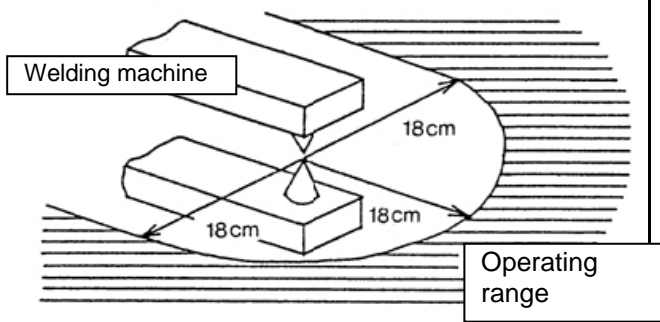

cover has to be removed, shut off the power before removal.

4. Disposal

Request a special agent for handling industrial waste to dispose the products.

3. Do not pull sensor cable strongly.

Such action may cause failure.

4. Water shall be kept away from the sensor unit to avoid failure. (IP65 Protection)

5. Power supply line

Do not mount any switch or relay to power supply line (12 VDC to 24 VDC).

Measurement

⚠ Caution

SMC products are not intended for use as instruments for legal metrology.

Measurement instruments that SMC manufactures or sells have not been qualified by type approval tests relevant to the metrology (measurement) laws of each country. Therefore, SMC products cannot be used for business or certification ordained by the metrology (measurement) laws of each country.

Maintenance and Check

⚠ Warning

1. Performing regular check

Check regularly that the products do not operate with failures unsolved. Check should be done by trained and experienced operators.

2. Dismantling of product and supply/exhaust of compressed air.

Before dismantling, ensure that drop preventing and runaway preventing treatments are properly provided, shut the power source of air supplied, and exhausts compressed air in the system. When starting operation again, operate the product with care after ensuring that a treatment for preventing extrusion is properly provided.

3. Prohibition of disassembly and modification

To prevent accidents such as failures and electric shocks, do not remove the cover to perform disassembly or modification. If the

1. General

1-1 Features

Controller (CEU2) is a special controller designed for Monosashi-kun with Brake. Upon the input, controller will stop the cylinder, smoothly and precisely at position as inputted.

Stopping positions of Monosashi-kun with Brake are stored into "Step", ranging from step 1 to 32. Steps will be grouped together and form as "Program". CEU2 allows maximum storage of 16 programs.

Program	P1	P2	P3	P16
Step	S1	S1	S1		S1
	S2	S2	S2		S2
	⋮	⋮	⋮		⋮
	⋮	⋮	⋮		⋮
	S32	S32	S32		S32

Following are CEU2's special feature: -

1. Predictive Control & Learning Function

(Allow High Repeatability and Precision, $\pm 0.5\text{mm}$)

With learning function, after every execution, brake point will be amended, according to the deviation of stopping position from setting position.

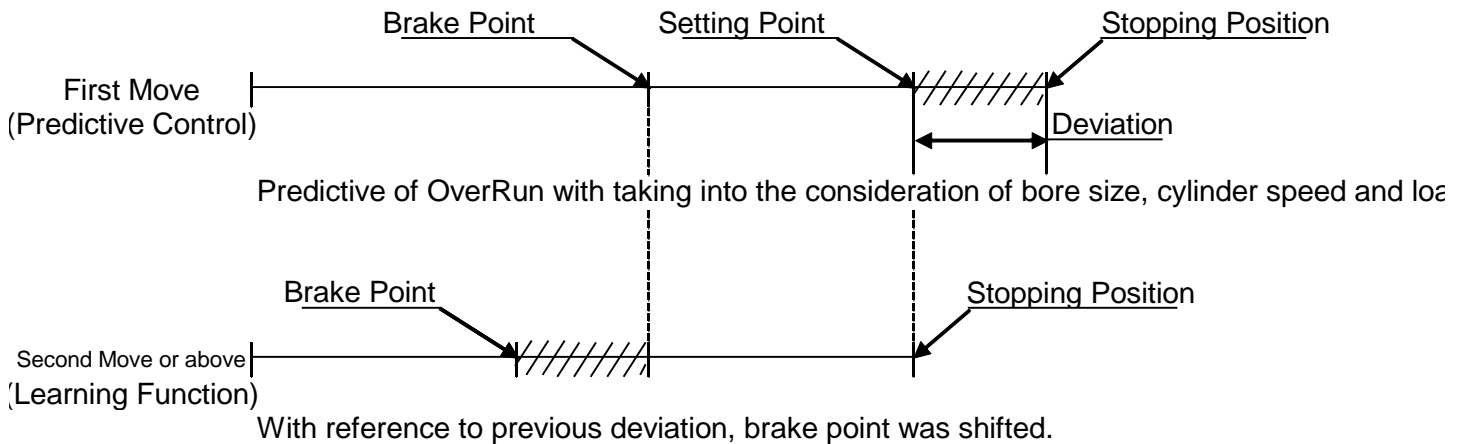

2. Equipped Function with Retries

→ If stopping position deviates from setting position's tolerance, retries function will execute to revise the brake point.

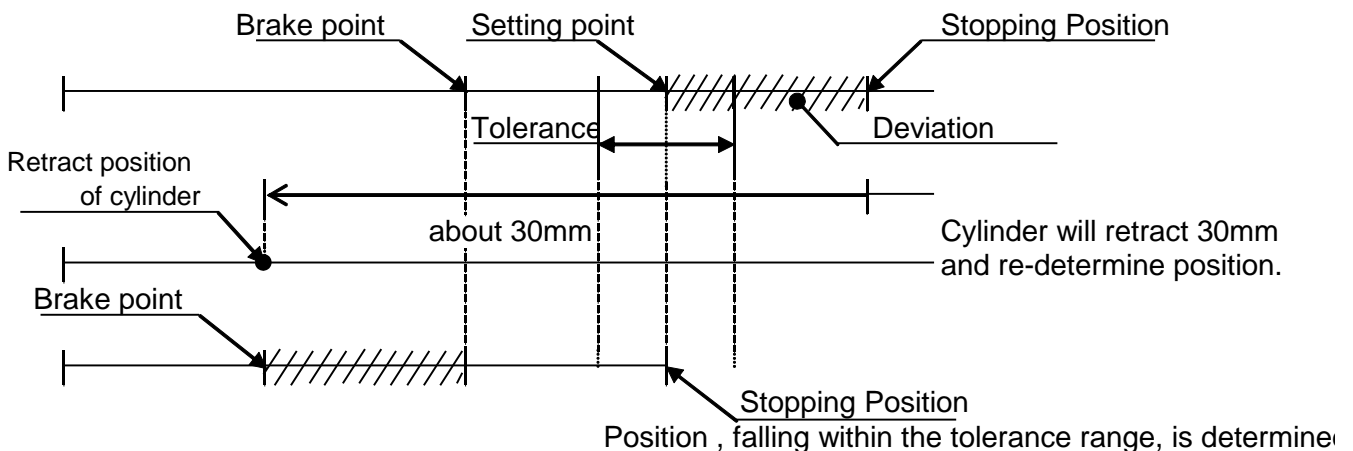

3. Error Detector

When System is found faulty, error detector will take action, detect and analyze error. Finally, error messages will be displayed. Thus, ease of debugging time.

4. DIN Rail installation is possible.

1-2 Position Control

1. With controller, valve outputs to achieve precise positioning.
2. For the situation whereby cylinder stopping position does not fall into the tolerance range, retries will be performed. First, it will retract (30mm), and then extend to achieve setting position.
3. With learning ability, brake point will be recognized and thus lead to precise positioning with taking into the consideration of factors like loading & pressure condition, momentum & impact when stopping.
4. Stopping method applied is through air balance and brake to lock the movement. While brake applies the combination of spring and pneumatic locking method.
5. Position is determined when positioning falls on the setting tolerance range.
6. Position determination will follow the sequence of selected program's steps.
7. Only programs are available for selection. Program steps are not selectable.

1-3 Positioning at Cylinder Rod End

Do not use cylinder with cushion, if determined position falls at cylinder rod's end (front or back). This is due to drastical change of speed occurring at the stroke end will lead to imprecision and easy occurring of learning error (Err 6).

2. System Configuration

2-1 System Checking Flow Chart

《CE2 (Monosashi - kun with brake) + CEU2 (Controller)》

Refer to check Flow, showing at next page, to determine brake position, so as to reduce the possibility of occurring errors, which are mostly due to the stopping precision, caused by brake position.

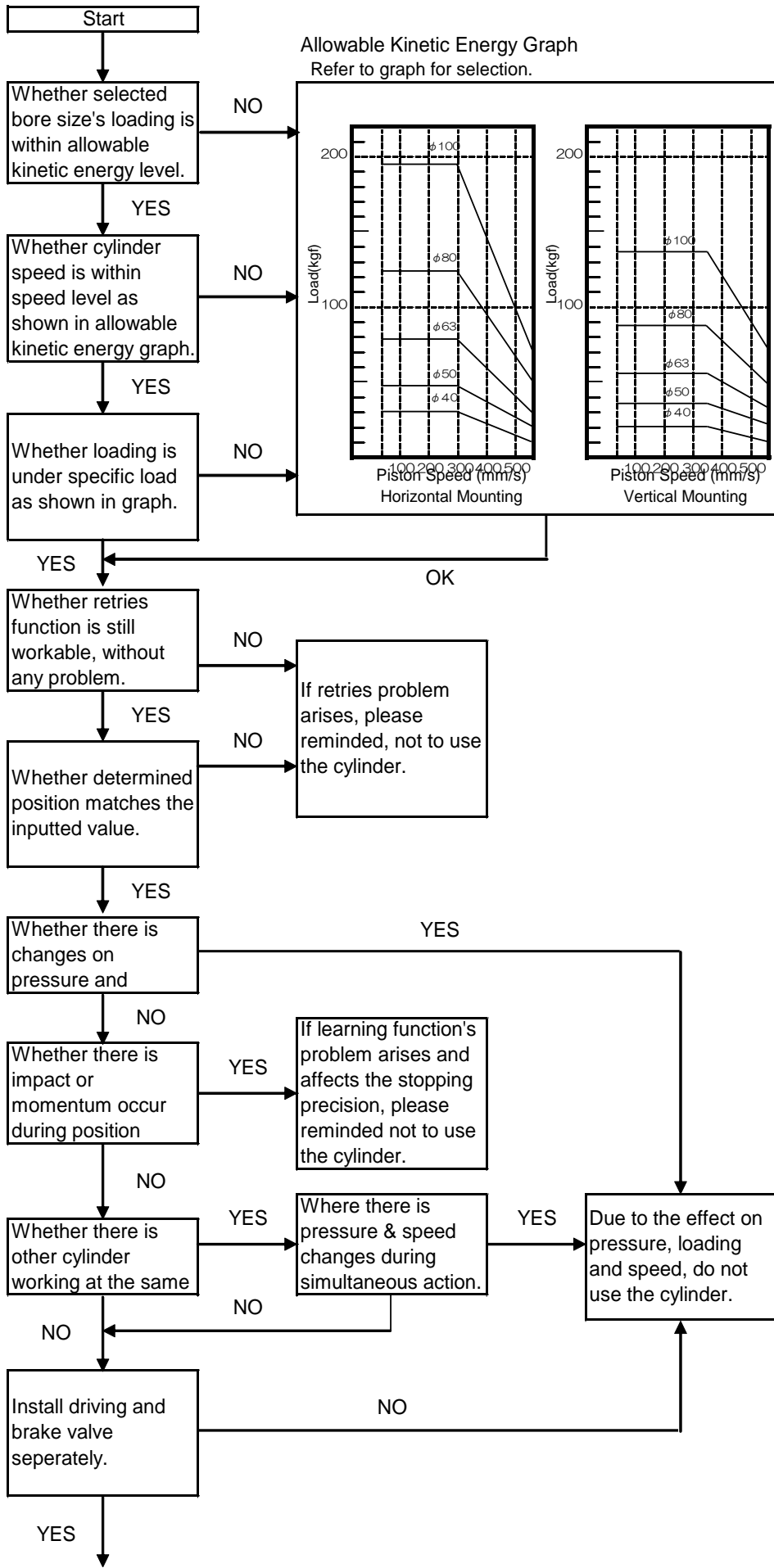

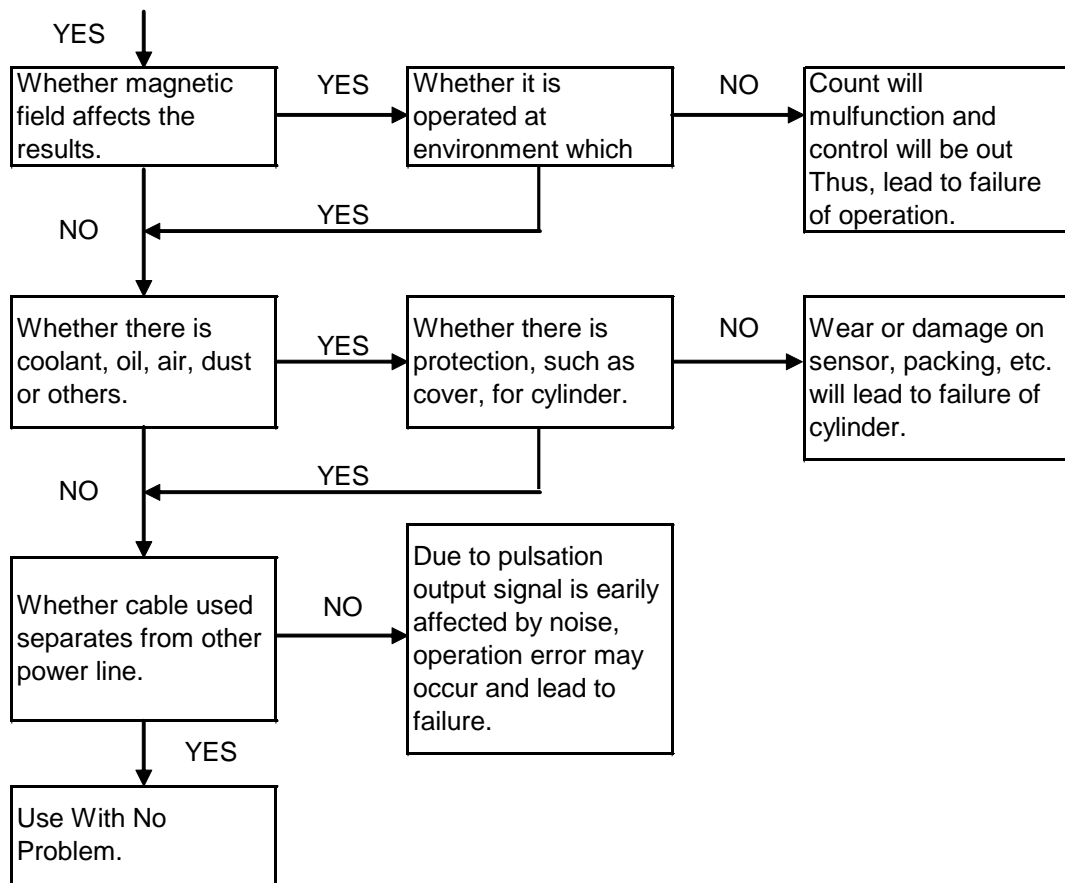

2-2 System Configuration

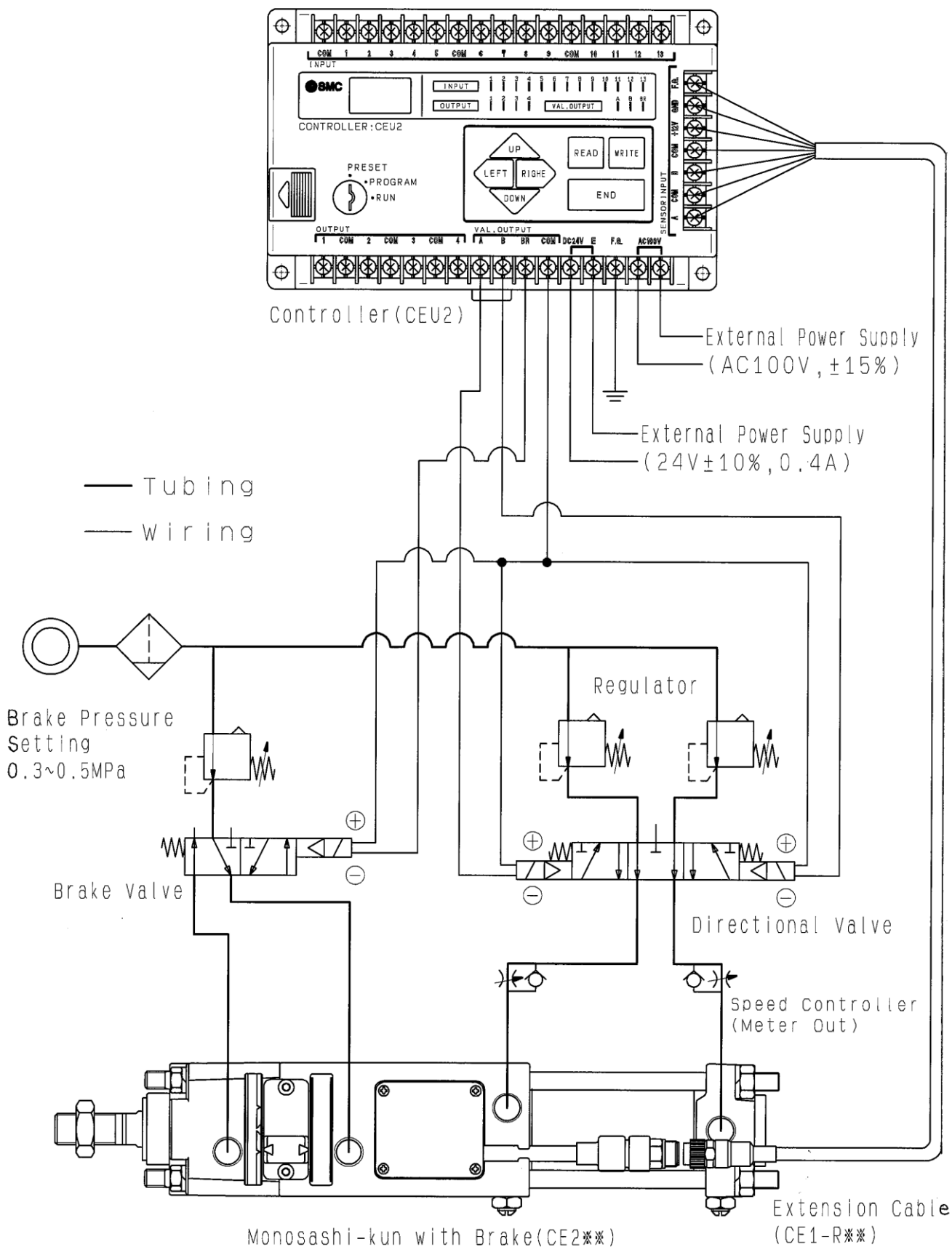

2-3 Recommended Circuit Design

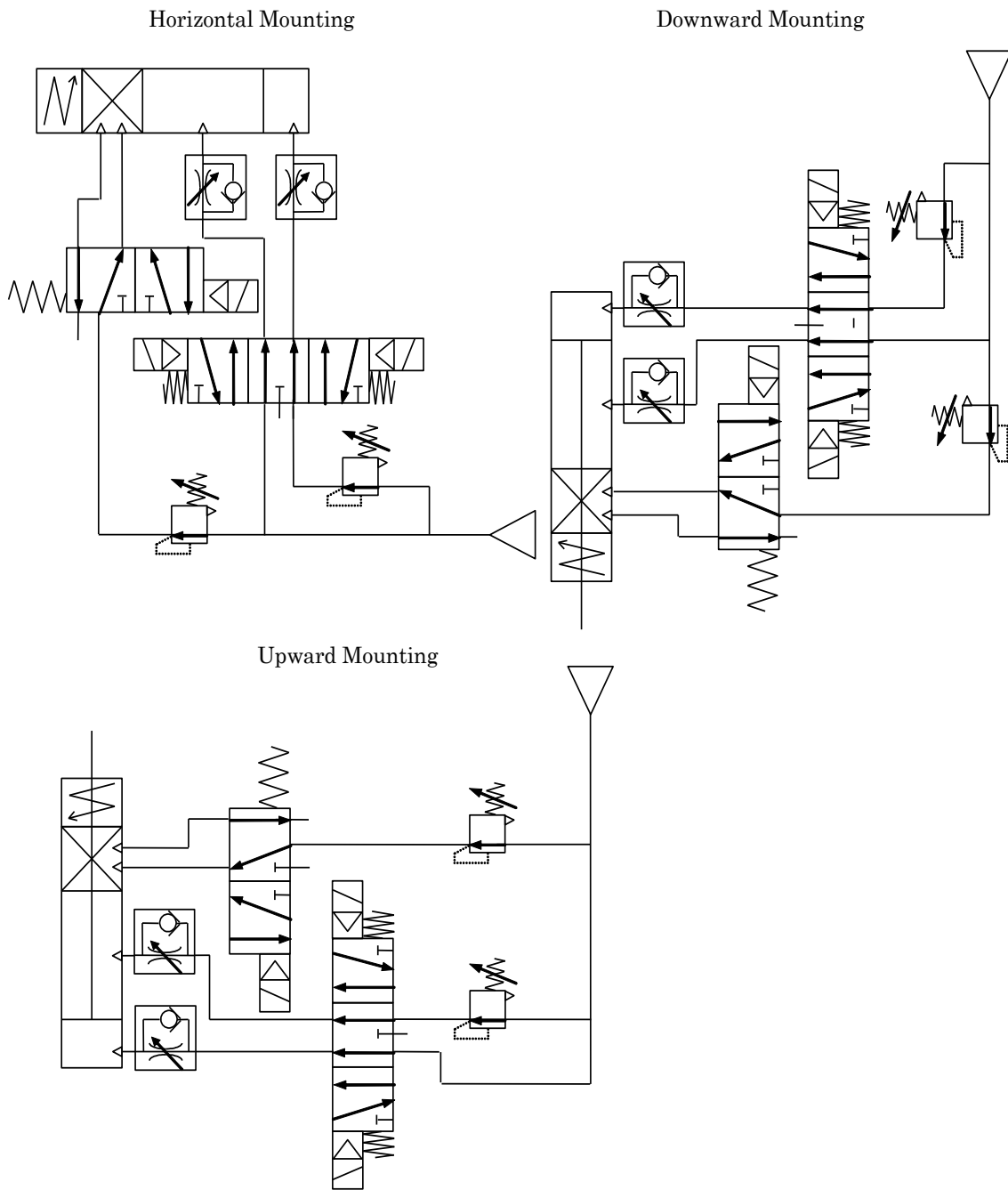

<Air Circuit Diagram>

Recommended Pneumatic Equipment

Bore	Directional valve	Brake valve	Regulator	Tubing	Silencer	Speed Controller
φ40	VFS24□0R	VFS21□0	AR425	Nylon φ8/6	AN200-02	AS4000-02
φ50	VFS24□0R	VFS21□0	AR425	Nylon φ10/7.5	AN200-02	AS4000-02
φ63	VFS34□0R	VFS21□0	AR425	Nylon φ12/9	AN300-03	AS4000-03
φ80	VFS44□0R	VFS31□0	AR425	Nylon φ12/9	AN300-03	AS420-03
φ100	VFS44□0R	VFS31□0	AR425	Nylon φ12/9	AN400-04	AS420-04

* Please install the silencer responding to it necessary.

3. SPECIFICATIONS

3-1 Cylinder Specifications

Bore Size	φ40	φ50	φ63	φ80	φ100
Operating Fluid	Air (Non-Lubricated)				
Proof Pressure	Drive Pressure : 1.5MPa Brake Pressure : 0.75MPa				
Max. Operating Pressure	Drive Pressure : 1.0MPa Brake Pressure : 0.5MPa				
Min. Operating Pressure	Drive Pressure : 0.1MPa Brake Pressure : 0.3MPa				
Piston Speed	50~500mm/s				
Ambient Temperature	0~60°C (No freezing)				
Maximum Stroke (Standard)	850mm	800mm	800mm	750mm	750mm
Brake Type	Integrated Pneumatic and Spring				
Sensor Cord Length & Type	φ7—500mm & Oil Resistant				
Hardware	JIS B0209				

3-2 Controller Specifications

Type	CEU2	CEU2P
Model Nomenclature	Controller	
Mounting	Surface Mounting (Din Rail or Screw)	
Operating Modes	PRESET · PROGRAM · RUN	
Display	Back lighted Display	
Position Setting Capacity	1—16 Programs, Each Program	1—32 steps
Position Control Method	PTP(Point To Point)	
Control Axes	One Axis	
Position Setting Method	Key Input to Controller	
Position Setting Range	9999.9mm	
Min. Setting Range	0.1mm	
Memory	8kbyte Static RAM (5-Year Battery Backup)	
Min. Setting Interval	5mm and above	
Input Signal	START, GOHOME, PROGRAM#, PAUSE, EMERG, STOP, SETHOME RESET, AUTO/MANUAL, IN/OUT(Manual mode only)	
Output Signal	Move Completed, At Home, Program End, Error	
Controlled Output	NPN Open Collector (DC30V, 50mA)	PNP Open Collector (DC30V,50mA)
Power Supply	AC100V±15%, 50Hz/60Hz & DC24V±10%, 0.4A	
Operating Temp. Range	0°C~50°C	
Operating Humidity Range	25%~85%	
Shock Resistance	10~55Hz, Amplitude 0.75mm Each Axis for 2 hours	
Noise Resistance	Square Wave (1μs Pulse Width) Between 100 VAC line±1500V, I/O line 600V	
Impact Resistance	10G, 3 times at each axis	
Proof Voltage	AC1500V, 1Min(less than 3mA) , between Case & AC Line AC500V, 1Min(less than 3mA) , between Case & 12VDC	
Current Consumption	Below 1.0A	
Insulation Resistance	DC500V with Above 50MΩ, between Case & AC Line	
Mass	690g	

3-3 Sensor Specifications

Cable	φ7, 6 Core Twisted Pair Shielded Wire (Oil, heat and flame resistance cable) (Connector : R03-R8M, Tajima Musen Denki Company)
Max. Transmission Distance	20.5m (when using SMC cable and controller or counter)
Position Detection Method	Magnetive Scaled Piston Rod & Detection Head (50cm Cable, Incremental Type)
Magnetive Field Resistance	14.5mT
Power Supply	DC10.8V~26.4V (Ripple less than 1%)
Current Consumption	50mA(MAX.)
Resolution	0.1mm/pulse
Accuracy	±0.2mm Note 1)
Output Type	Open Collector (30V, 50mA)
Output signal	Phase A & B with Differential Output
Max. Response Speed	500mm/s
Proof Voltage	AC500V, 1 min (Case to 12E)
Insulation Resistance	DC500V, above 50MΩ (Case to 12E)
Shock Resistance	33.3Hz6.8G, 2hours at X, Y and 4 hours at Z JIS D1061 as standard
Impact Resistance	30G, 3 times at each axis
Moisture Resistance	IP-65 <IEC STD> Except connector
Extension Cable (Option)	5m, 10m, 15m, 20m (Connector : R03-P8F, Tajima Musen Denki Company)

Note 1) This includes the digital display error of the controller (CEU2).

The overall accuracy after mounting on equipment will vary depending on the mounting conditions and environment. Therefore, the customer should calibrate the system as a whole.

4. MODEL

4-1 Monosahi-kun with Brake

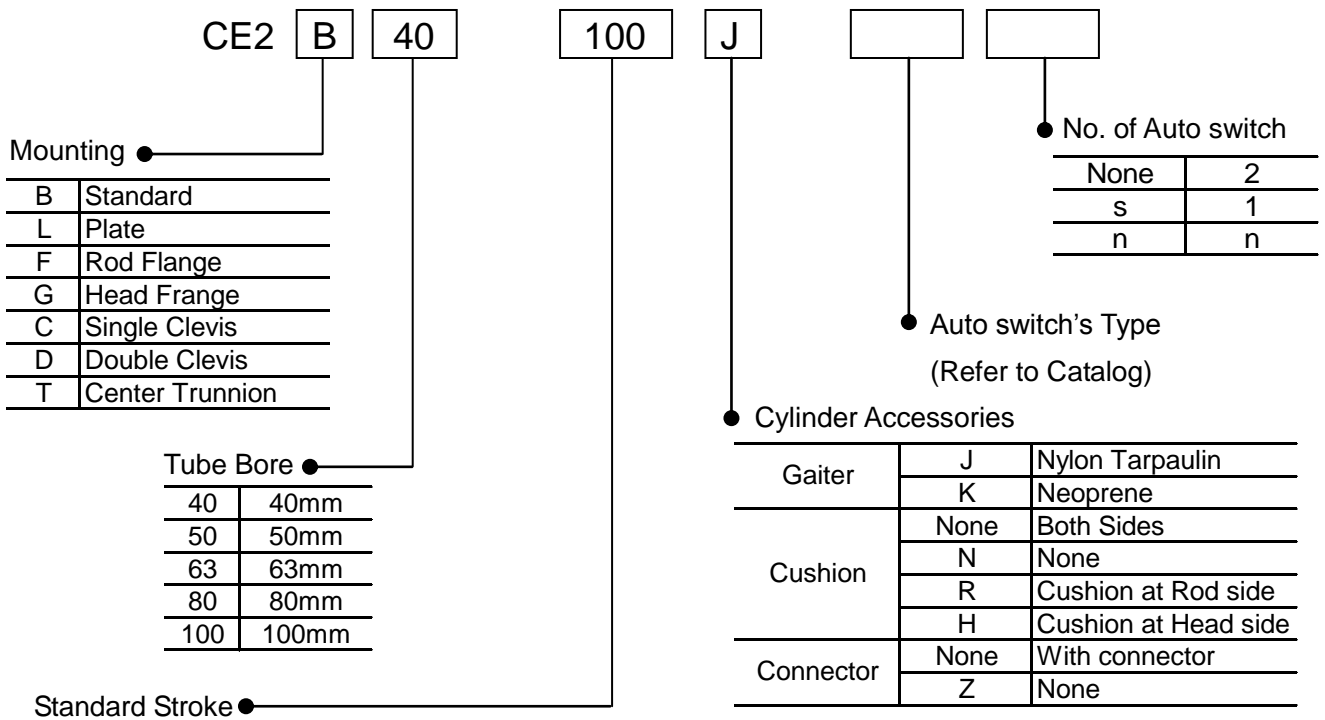

Tube Bore(mm)	Standard stroke (mm)		Range of manufacturable stroke	
	Without Gaiter	With Gaiter	Without Gaiter	With Gaiter
40	25~850	25~700	1200	950
50	25~800	25~650	1150	900
63	25~800	25~650	1150	900
80	25~750	25~600	1100	900
100	25~750	25~600	1100	850

4-2 Controller

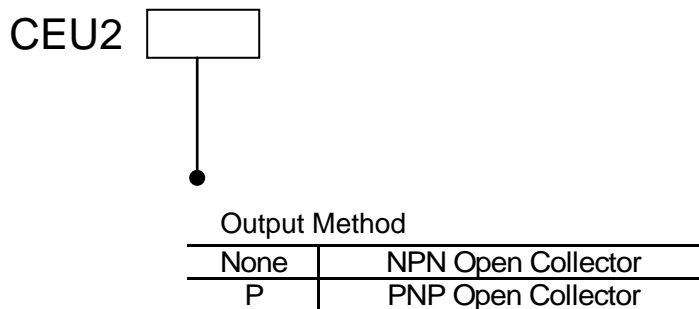

4-3 Extension Cable

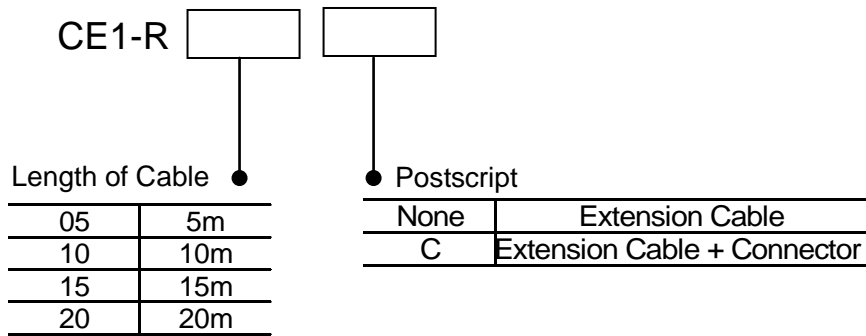

Connector's Connection

Symbol	Core Wire Color
A	White
B	Yellow
C, D	Brown, Blue
E	Red
F	Black
G	(Shield)

0X 940

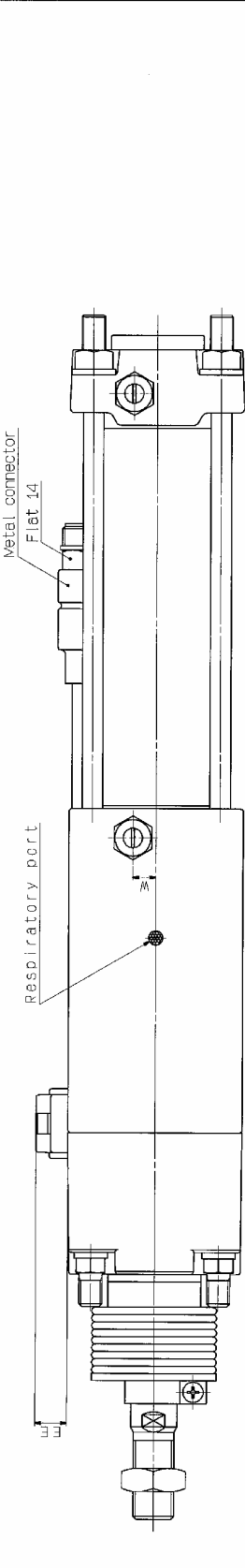
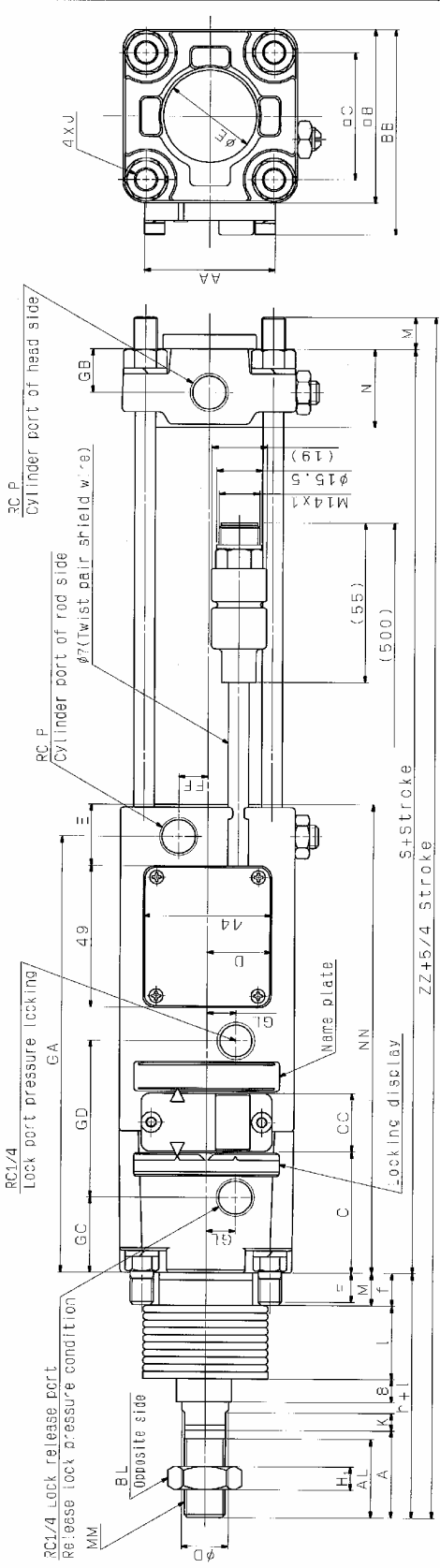

BORE SIZE (mm)	STROKE RANGE	A	AA	AL	BB	BL	DB	C	CC	CC	D	φD	E	EE	FF	GA	GB	GC	GD	GL	H ₁
40	20~500	30	45	27	71	22	60	42	20	44	22	16	21	11	32	10	150.5	152	64	10.8	
50	20~600	35	50	32	80	27	70	46	21	52	24	20	28.5	10	40	10	162.5	172	59	13.1	
63	20~600	35	60	32	88	27	85	48.5	23	64	24	20	28.5	13	40	12.5	174	172	67	18.1	
80	20~750	40	70	37	117	32	102	55	23	78	26.5	25	36	15	52	15.5	179	21	30	72	23.13
100	20~750	40	80	37	131	41	116	56.5	25	92	35.5	30	36	15	32	15.5	198	21	31	76	25.16

BORE SIZE (mm)	J	K	M	MM	N	NN	P	S	W	φE	T	I	ZZ
40	M8x1.25	6	11	M4x1.5	27	161.5	RC1/4	218.5	8	43	11.2	59	288.5
50	M8x1.25	9	11	M4x1.5	30	175.5	RC3/8	235.5	0	52	11.2	66	312.5
63	M10x1.25	9	13.5	M4x1.5	31	187	RC3/8	254	0	52	11.2	66	333.5
80	M12x1.75	11	16.5	M2x1.5	37	205	RC1/2	284	0	65	12.5	80	381
100	M12x1.75	11	16.5	M2x1.5	40	214	RC1/2	300	0	65	14	81	398

ITEM	DESCRIPTION	DATE	PREPARED	REV. NO.	MODEL	UNIT
1	DESIGN	2010-03-22	M. FUJITA	F REE		
2	DESIGN	2010-03-22	K. FUGIWARA	F REE		
3	CHECKED	2010-04-14	J. SUGIYAMA			
4	APPROVED	2010-04-14	T. KANDA			

MONSASHI-KUN WITH BRAKE AND GAITER
REV. NO. 3
DATE 2010-04-14

FINISH: 標準 / PAINT: 標準 / PACKING: R40Z
MATERIAL: 鋼 / MATERIAL SIZE: 標準

SMC Corporation

A2-V05

5-2 Controller

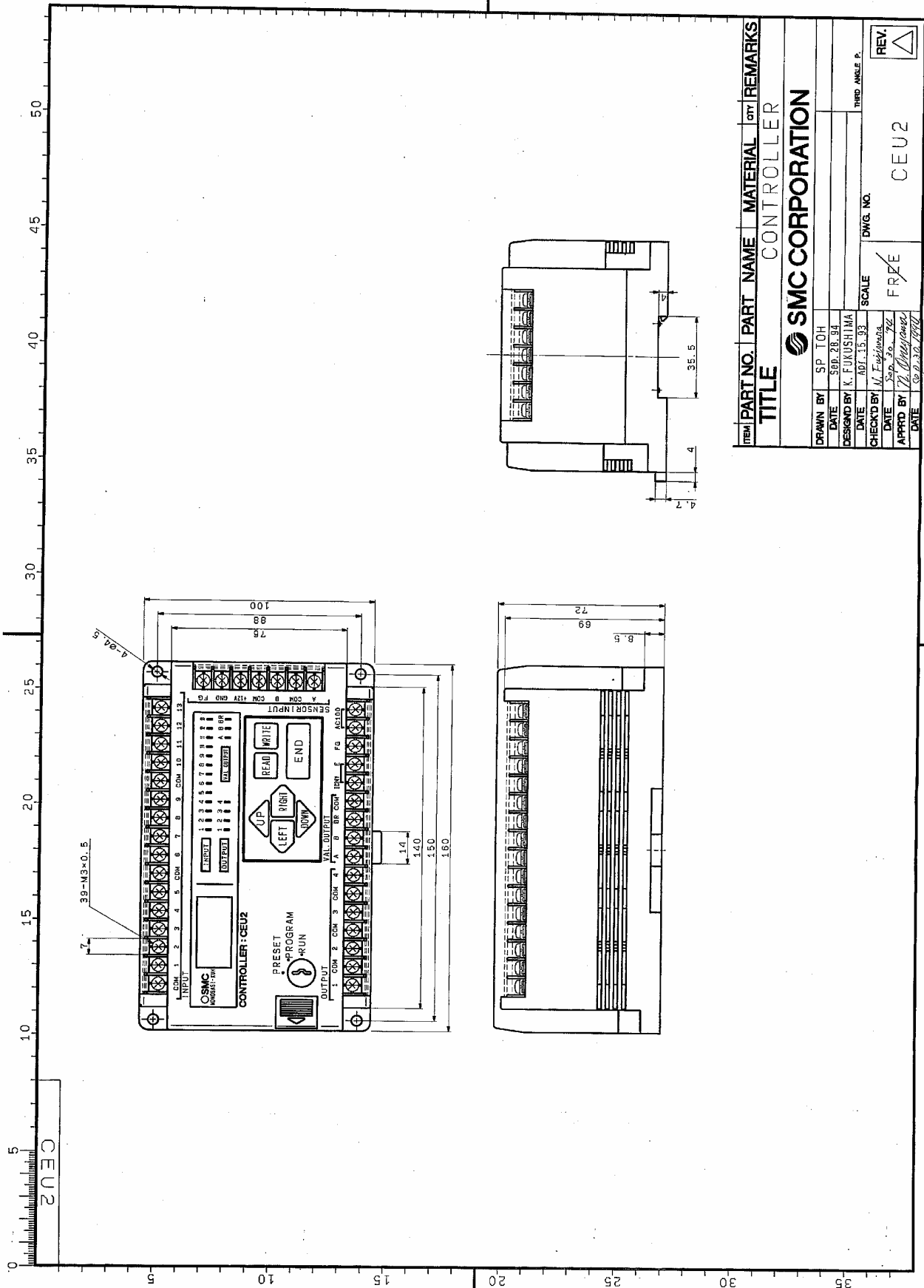

ACT5547700

886

ON 9MO

CE1-R**

Table 1

Part No.	L
CE1-R05*	5 ^{+0.1} m
CE1-R10*	10 ^{+0.2} m
CE1-R15*	15 ^{+0.3} m
CE1-R20*	20 ^{+0.4} m

CE1-R00C

CE1-R**

CE1-RC**

Combinations of contact mark and core color

contact mark	core color
A	White
B	Yellow
C	Brown
D	Blue
E	Red
F	Black
G	Shield

connector pin layout

Meshed shield

Specification

Connector

Withstand voltage(Voltage-proof) AC700V for 1 minute

Insulation resistance DC500V over 1000MΩ

Cable

Withstand voltage(Voltage-proof) AC1000V for 1 minute

Insulation resistance DC500V over 10MΩkm

ITEM	PART NO	PART NAME	MATERIAL	QTY	REMARKS
4	R03-J8M	Metal Connector		1	TAJIMI MUSEN
3	H15-A-1876-BK H15M-1876 SERV-SVT2604	Heat shrinkage tube Cable		1	HELLERMANN TYTON =REFER=
2	CE1-C200	Cable		1	OKI-DENKI
1	R03-P8F	Metal Connector		1	TAJIMI MUSEN

Change the ITEM 2 and 3 2009-05-27 (HAGIWARA#-DMND119)

REV. QTY	DESCRIPTION	DATE PREPARED	REV. NO	SCALE	MODEL	QTY
1	1	1	1	1	1	1

DRAWN M. Fujita
DATE 2009-05-27

DESIGNED K. Hagiwara
DATE 2009-05-27

CHECKED JSakashita
DATE 2009-05-27

APPROVED NFujiwara
DATE 2009-05-27

EXTENSION CABLE

DWG NO

REVISION

CE1-R**

DWG ID/AC14065401

S&M Corporation

A3-V05

FINISH: 表面処理 / PAINT: 塗装 / PACKING: 包装区分

MATERIAL: 材質 / MATERIAL SIZE: 材料寸法

6. Part Identification

6-1 Monosashi-kun with Brake

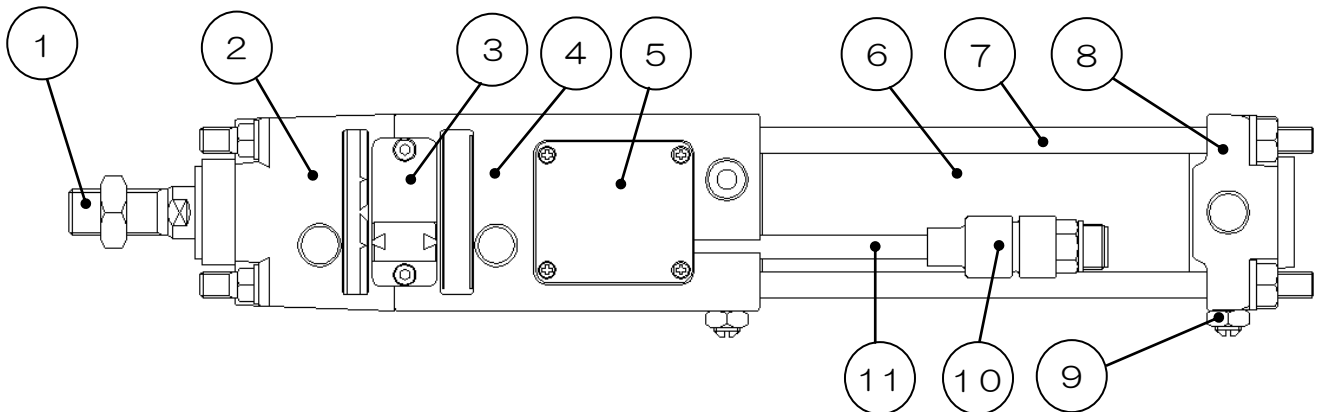

- | | | |
|-------------|---------------|----------------|
| ①Piston Rod | ②Cover | ③Pin Guide |
| ④Rod Cover | ⑤Sensor Cover | ⑥Cylinder Tube |
| ⑦Tie Rod | ⑧Head Cover | ⑨Cushion Valve |
| ⑩Connector | ⑪Cable | |

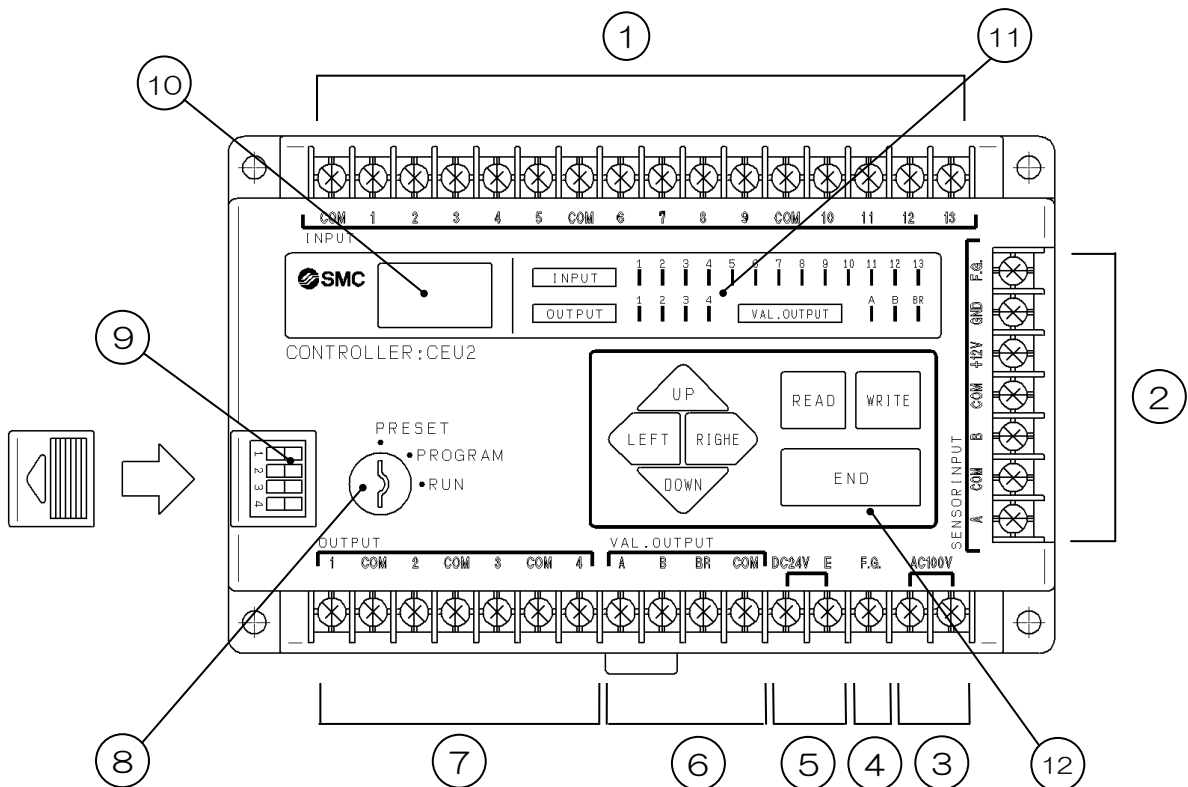

- | | | |
|---------------------------|------------------------|-----------------------------------|
| ①External Input Terminal | ②Sensor Input Terminal | ③AC Power Supply Input Terminal |
| ④Earth Terminal | ⑤DC Input Terminal | ⑥Valve Output Terminal |
| ⑦External Output Terminal | ⑧Mode Switch | ⑨Dip Switch for Condition Setting |
| ⑩LCD Display | ⑪Input Signal Monitor | ⑫Input Data Key |

7. Installation & Wiring

7-1 Installation

7-1-1 Installation of Cylinder

1. During installation of metal fitting onto the end (screw thread) of piston rod, prevent from the induction of impact and unbalance loading acting upon it.
2. During mounting of cylinder and load, care should be taken not to give misalignment non twist. Please attach floating joint between the connection.
3. Make sure that pushing force of cylinder act on the centre of load.
4. Do not disassemble cylinder and dismantle sensor from cylinder.
5. Flushing of pipe should be done. Prevent dust & dirt entering into cylinder. Moreover, mist separator should be used to get rid of water vapor, oil and dirt from the utilized comprised air.
6. When oil is needed to be fed in, use turbine oil class 1 (ISO, VG32).
7. If there is a lot of dust at working environment, use gaiter. Besides that , please take note that operating temperature should be kept between 0 to 60°C.
8. The total length of air piping (from cylinder to solenoid valve) should be kept below 1m.

7-1-2 Installation of Controller

1. During installation of controller, use M4 bolt and DIN rail.
2. Prevent from direct shining of sun, high or low temperature's environment.
[Operating temperature range : 0°C~50°C]
3. Do not utilize it at high humidity's environment.
[Operating humidity range : 25%~85%]
4. Keep it within noise protection material and away from high voltage and power supply wire.
5. Prevent it from mounting in environment containing a lot of dust, salinity, ferrous, or flammable, corrosive gas.
6. Do not mount it at high vibration and impact environment.
[Proof Vibration : 10~55Hz, range 0.75mm, x, y, z each axis for 2 hours]

7-2 Wiring

7-2-1 The Connection of Power Supply

Power Supply Specification : AC100V \pm 15% (AC85V~AC115V), 50/60Hz
DC24V \pm 10%, 0.4A

Use wire with 0.75mm² or more in the diameter of wire sectional area and twist it.

FG is meant for preventing lightning strike, use wire, 0.75mm² or more in the diameter of wire sectional area, to connect to earth.

If FG is not connected to earth, controller's noise filter will not be able to function properly. Hence, noise will be generated and lead to misreading / disoperation of cylinder.

7-2-2 The Connection of Extension Cable

Use specified (SMC) extension cable. Cable length, 5m~20m, with interval of 5m. For distance more than 20m, use specified transmitter • Receiver box (Model : CE1-H0374)

* Example on cable Connection

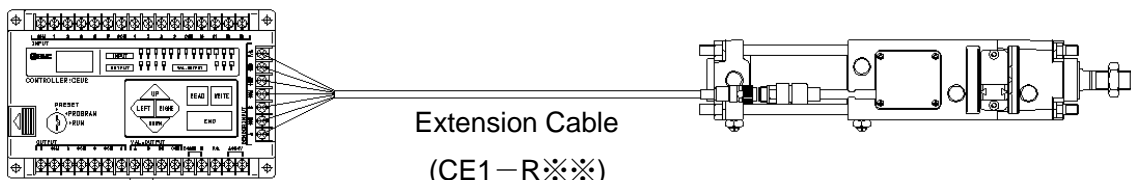

Above 20m

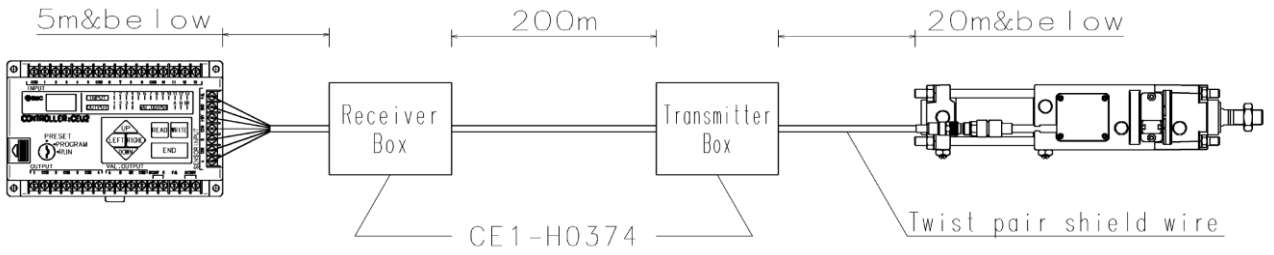

* Wiring of Transmitter box and Receiver box

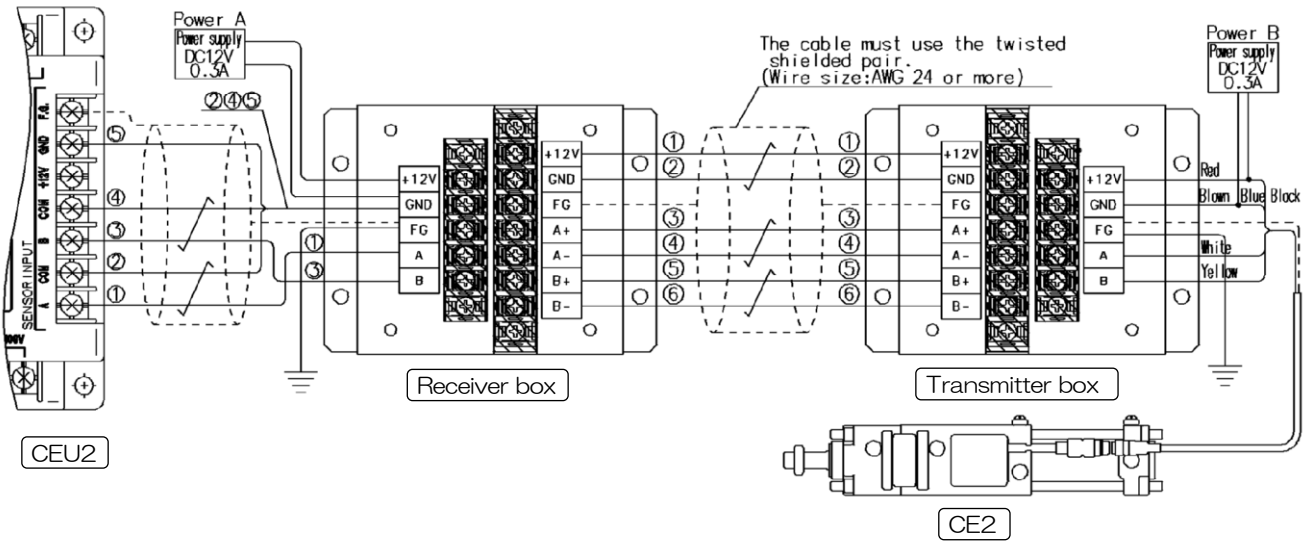

* Note

1. Clamp and fix the connector and sensor connection to reduce tension acting on them.
2. Separate cable with power line to prevent from the occurring of noise.
3. When cable is necessary to have U bend, set the bending radius to be above 25mm.

Bending Ability: According to drawing shown below, life span 4 million cycles or more can be achieved.

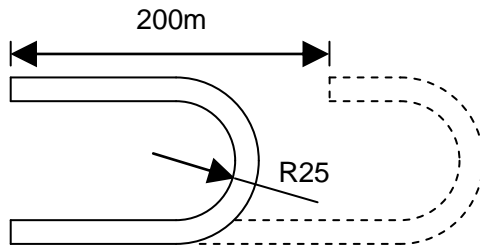

Reciprocating with
Bending Speed, 100 times/sec

7-3 Input/Output Signal Wiring

7-3-1 Input/Output Signal Wiring Diagram

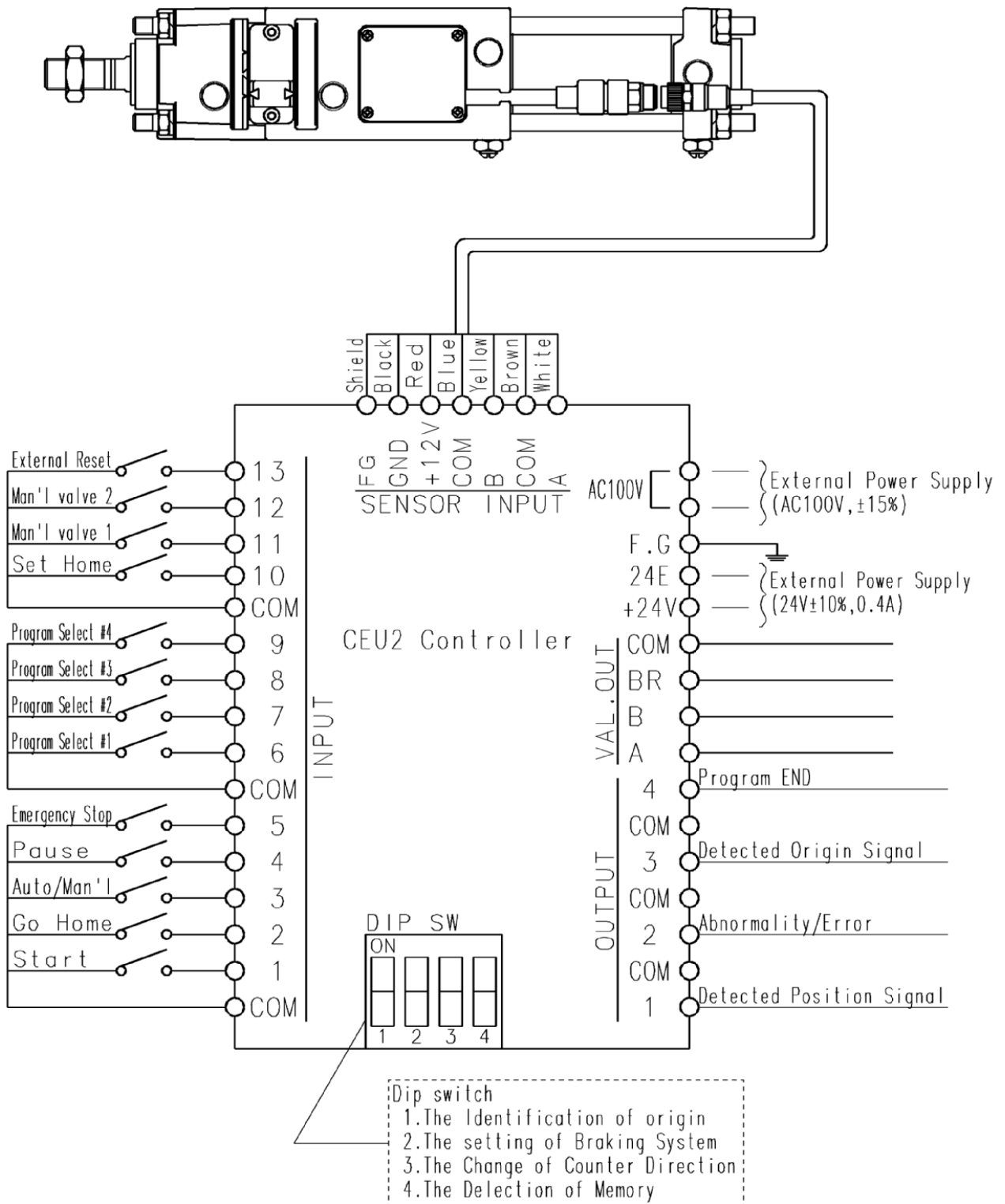

7-3-2 Input Signal Content

- Start.....Once started, setting position will be inputted. One step of movement per one shot (above 50msec).
 Note: Start signal (above 50msec's signal) will be received and activated to carry out subsequence step, only if homing has been performed and origin signal has been fed back to controller.
- Homing.....When cylinder rod returns to origin, signal above 50msec will be inputted.
- Auto / Man'l.....When the terminal and COM are in open state, auto mode is on. Vise versa (short circuit), manual mode is on.
 Auto mode.....When start signal is inputted. Motion will be executed step by step.
 Hand mode.....Man'l 1 (terminal 11) or Man'l 2 (terminal 12) and COM is short circuit to control either moving forward or backward.
 Motion direction depends on tubing and wiring.
- Pause.....During positioning, motion is stopped by this command. When the command is cancelled, positioning will be resumed from the stopped position.
 Note: Please note that Err5 (operating error) will arise, if the stopping position after pausing is less than 5mm away from setting point.
- Emergency Stop.....During positioning, the input of this command will force immediate stoppage of executing motion. After signal inputs, controller will show error message, Err10.
 Note: After emergency stop, homing will perform
- Program selection 1,2,3 & 4.....Select program according to following table (Binary Cord): -

Program No.	N Terminal No.			
	6	7	8	9
1	0	0	0	0
2	1	0	0	0
3	0	1	0	0
4	1	1	0	0
5	0	0	1	0
6	1	0	1	0
7	0	1	1	0
8	1	1	1	0
9	0	0	0	1
10	1	0	0	1
11	0	1	0	1
12	1	1	0	1
13	0	0	1	1
14	1	0	1	1
15	0	1	1	1
16	1	1	1	1

0...Open between IN6~9 and COM
 1...Short Circuit between IN6~9 and COM

- Set Home.....When dip switch No.1 is set ON, origin's signal is inputted. If dip switch No.1 is set to OFF, auto switch signal input is not required.
- Man'l 1
 Man'l 2Used at Manual Mode. When signal is inputted, cylinder rod either moves forward or backward.
- External Reset...The input of signal above 50msec will lead to reset of the system. When error occurs, execute RESET.

7-3-3 INPUT's Wiring

Input signal consists of 13 signals. With +24V input, +5V is isolated by photo-coupler.
 Signal's name: Start, Homing, Man'l / Auto, Pause, Emergency Stop, Program selection #1, Program selection #2, Program selection #3, Program selection #4, Set Home, Man'l 1, Man'l 2 and External Reset.

Input internal circuit is shown below:

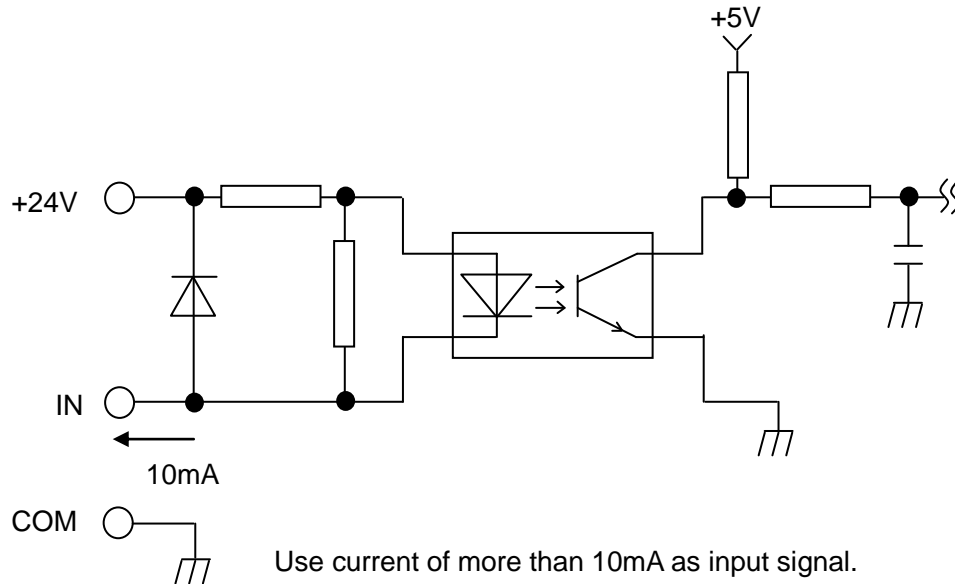

7-3-4 OUTPUT's Wiring

Output signal consists of 4 signals. Together with +5V, photo-coupler is insulated from the 4 output.
 Signal's name: Position Detected, Origin Calculated, Program End, Error
 Maximum terminal Voltage: DC +30V
 Maximum Current: 50mA (0°C~50°C)

Output Internal's Circuit

Model	Connection Method
CEU2	<p>NPN Output Transistor</p> <p>Controller: CEU2</p> <p>Max DC +30V, 50mA</p>
CEU2P	<p>PNP Output Transistor</p> <p>Controller: CEU2P</p> <p>Max DC +30V, 50mA</p>

8. Timing Chart

Homing Timing Chart

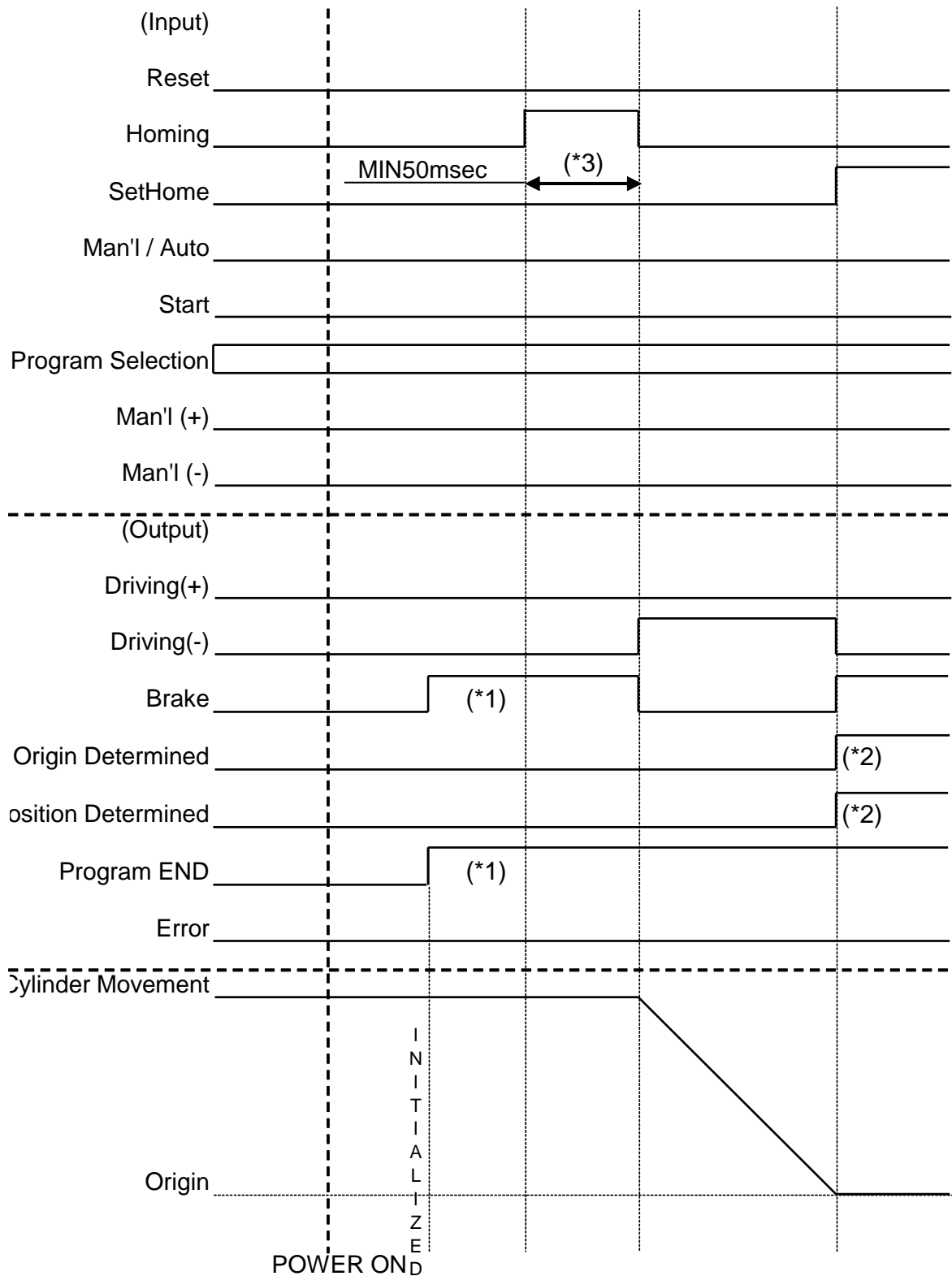

Note: Homing will be executed only on RUN mode and during automatic executing.

(*1)After resetting and re-supplying power, controller will need 2.0 sec (max) to resume operation.

(*2)Timing from stopping till output is the preset timing t1 (preset data P7).

(*3)Refer to P.27 7-3-6 Sequencer.

Automatic Executing's Timing Chart

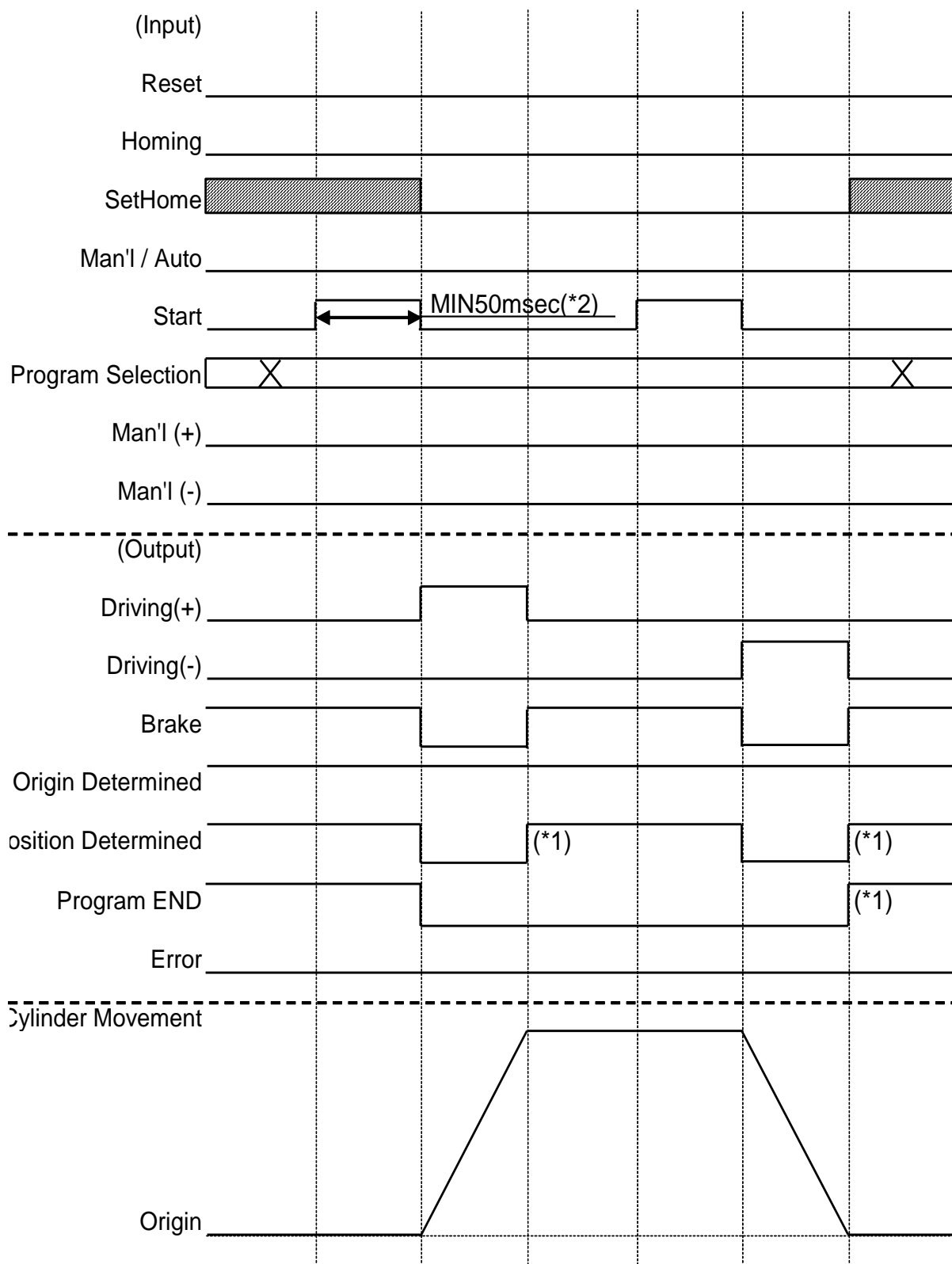

Note: After starting, program selection is not valid until program END.

Perform program selection before inputting START signal.

(*1)Timing from stopping till output is 0.2sec (max).

(*2)Refer to P.27 7-3-6 Sequencer.

Automatic Execution Timing Chart (Activation of Manual mode during motion)

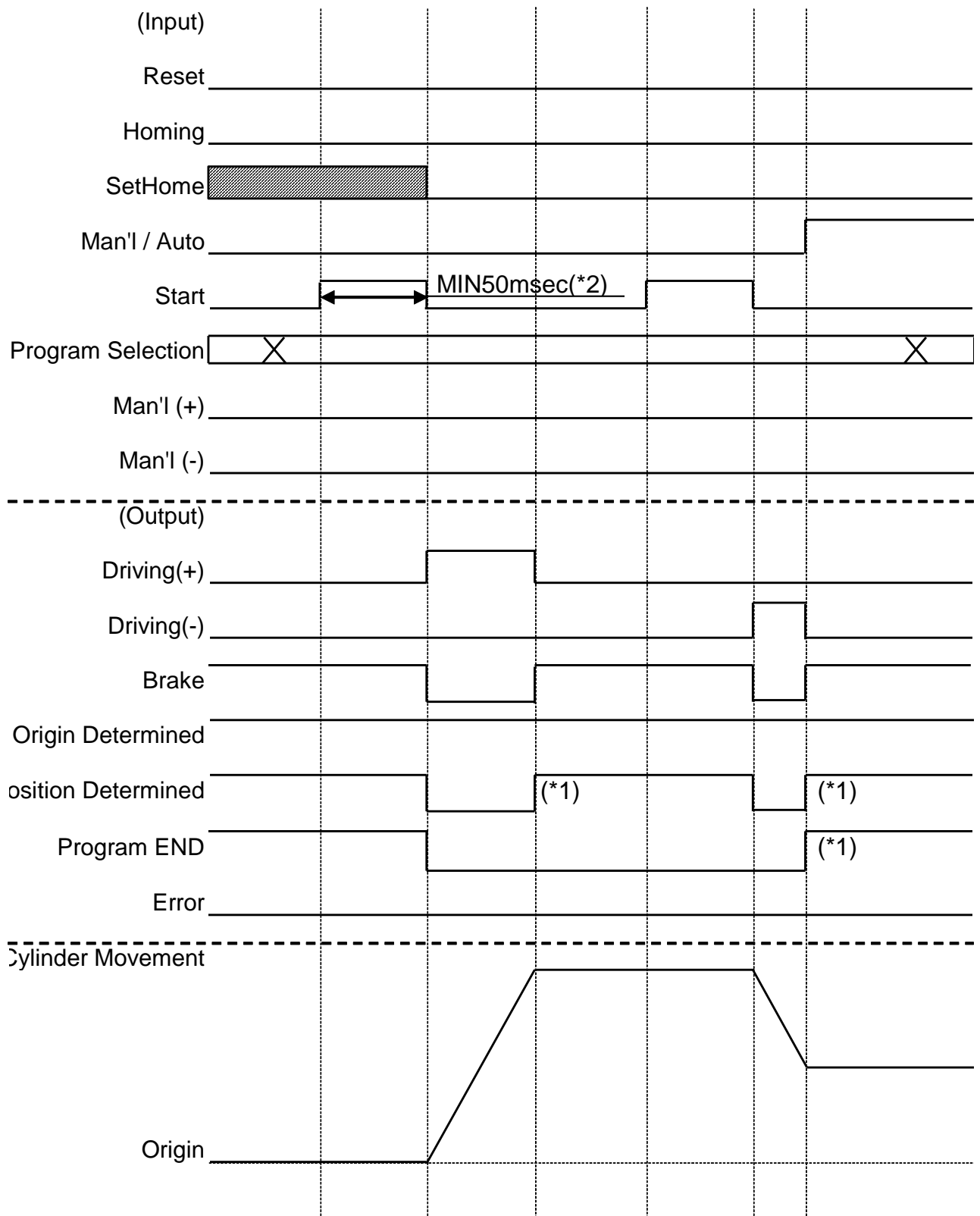

Note: If Manual mode or Run Mode is activated during Auto Mode, motion will stop.

(*1)Timing from stopping till output is 0.2sec (max).

(*2)Refer to P.27 7-3-6 Sequencer.

Manual Executing Timing Chart

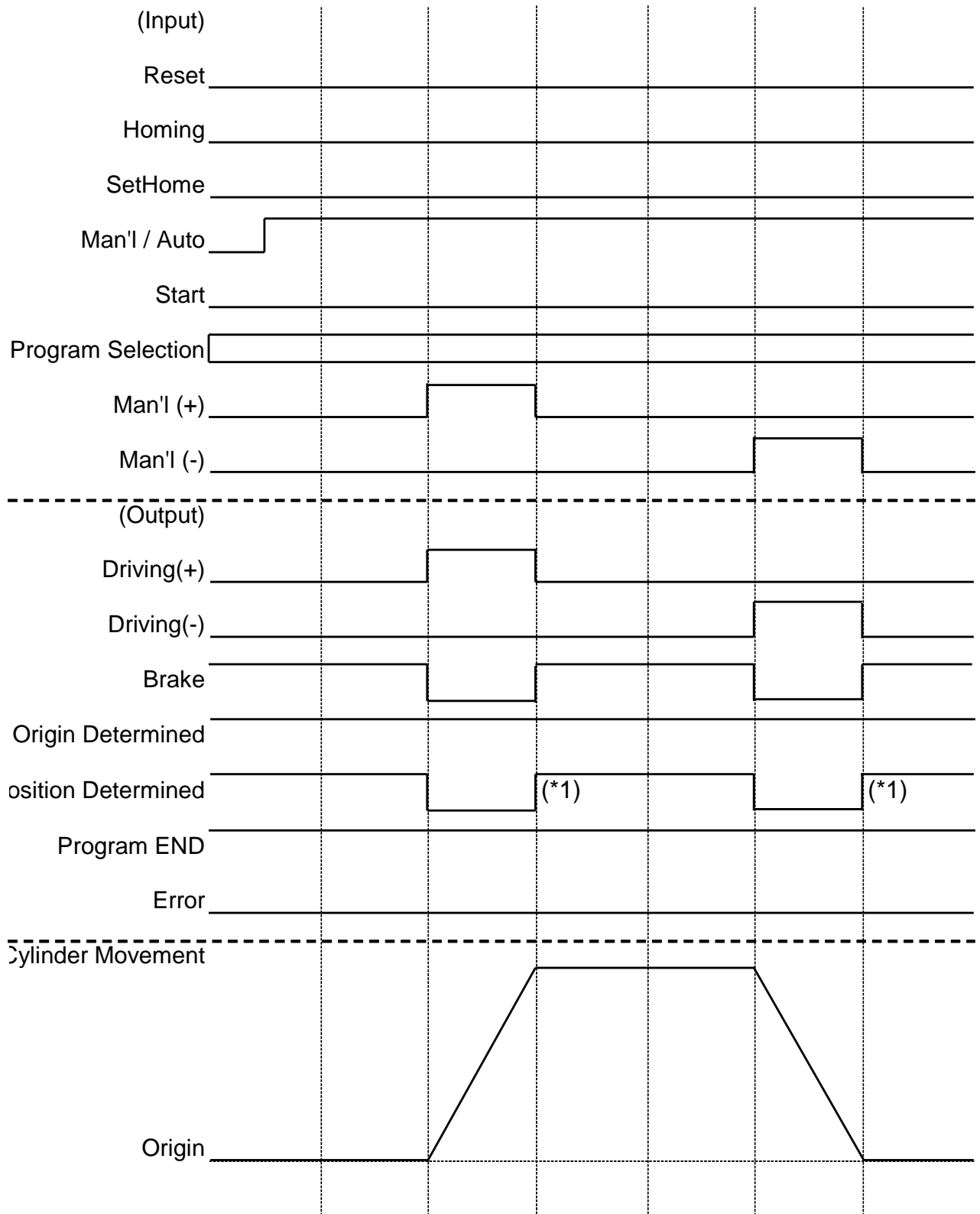

Note: During manual operation, Start signal is not effective.

Pressing Man'l (+) and Man'l (-) together will not take effect too.

Despite software determines origin, manual operation will be executed.

(*1) Timing from stopping till output is 0.2sec (max).

Pause during homing Timing Chart

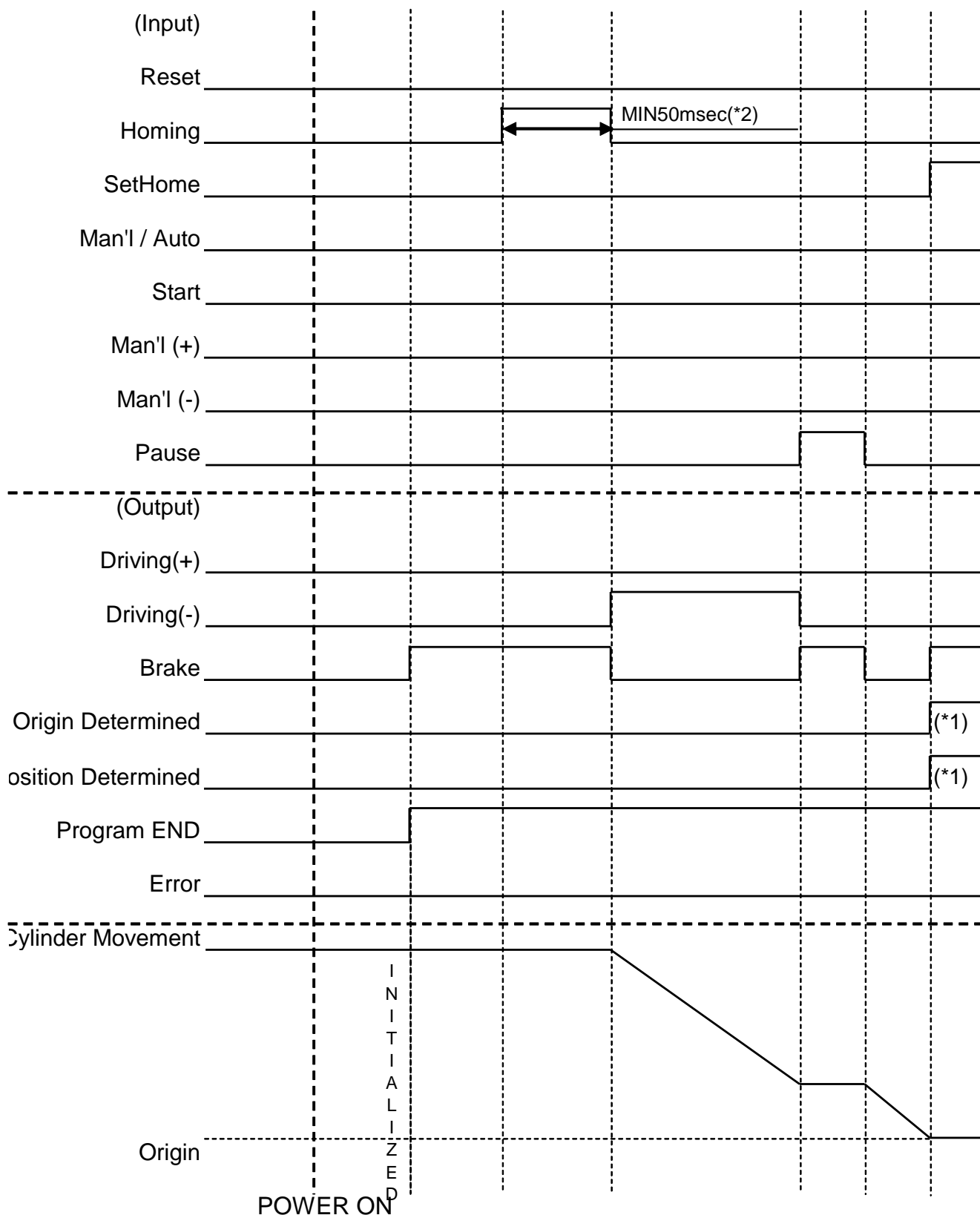

Note: Homing will be executed, only on RUN mode and during automatic executing.

(*1) Timing from stopping till output is the preset timing t1 (preset data P7).

(*2) Refer to P.27 7-3-6 Sequencer.

Pause during Automatic Execution Timing Chart

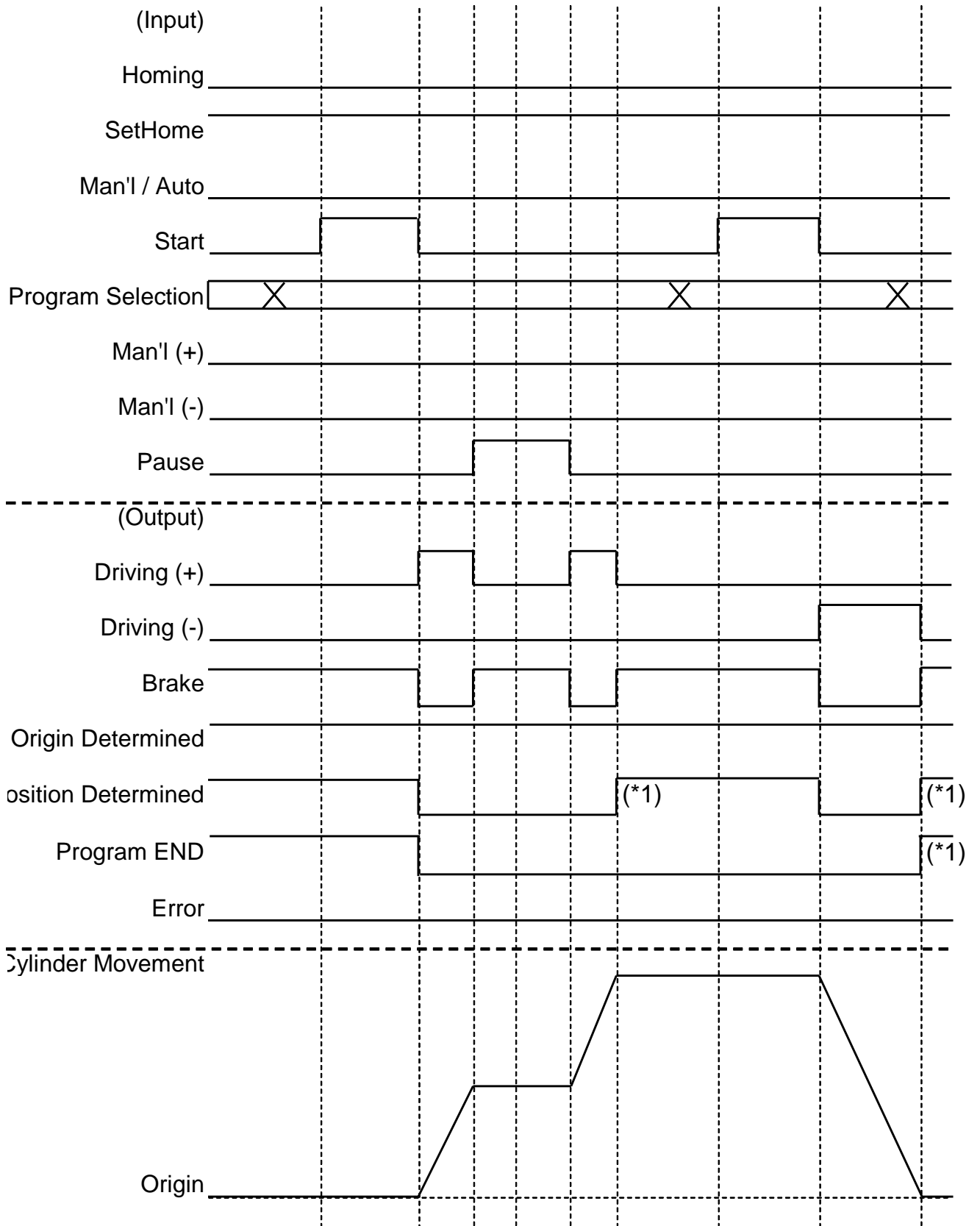

Note: During manual operation, Pause is effective less.

(*1)Timing from stopping till output is 0.2sec (max).

Emergency Stop (Automatic Execution) Timing Chart

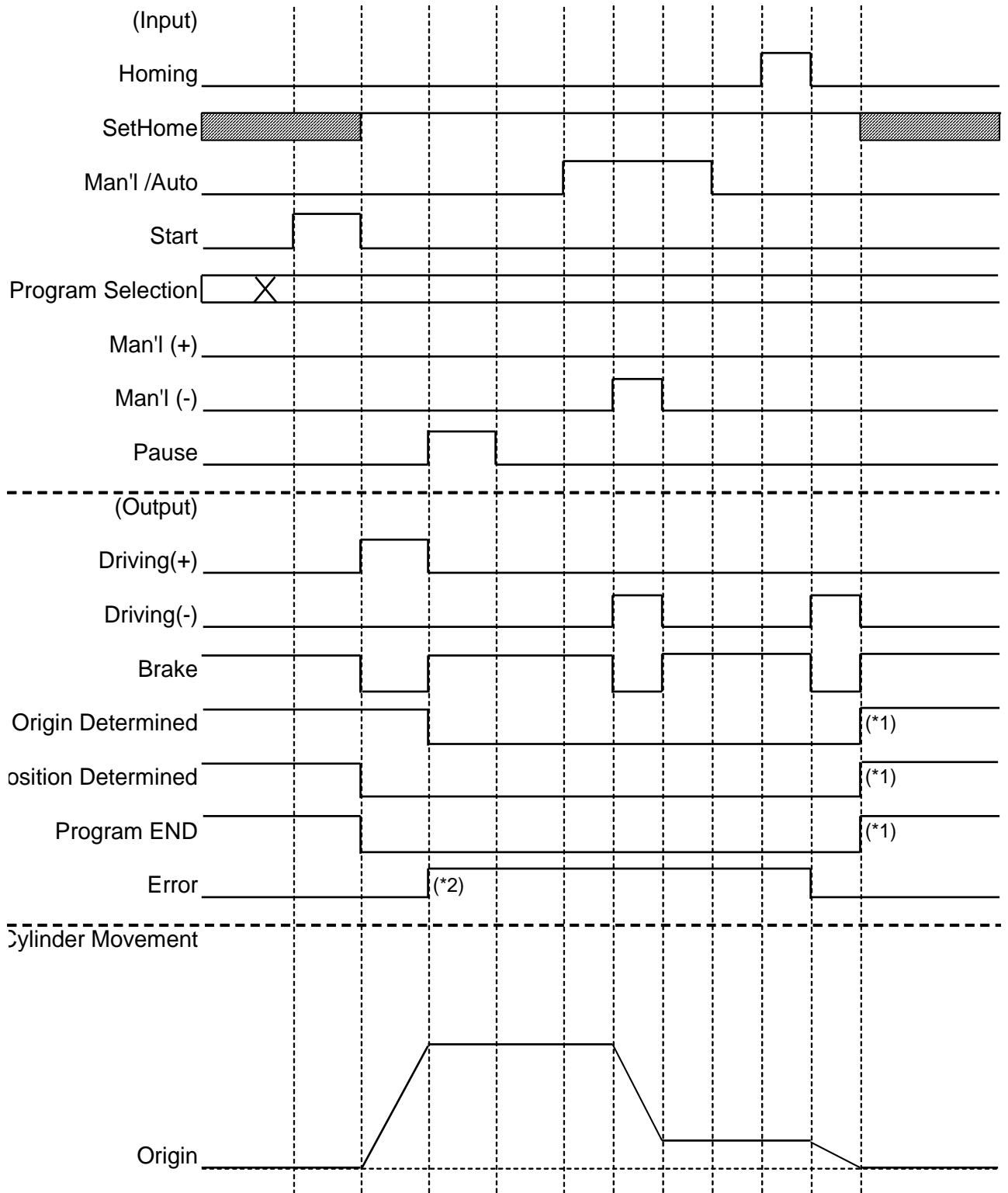

Note: When Emergency Stop is set to be ON, error will be also set ON. Vice versa.

Therefore, the display of error does not really show that error output.

Emergency Stop is also effective at Manual mode.

(*1) Timing from stopping till output is the preset timing t1 (preset data P7).

(*2) Timing from stopping till output is 0.2sec (max).

Data Error (Program free of error) Timing Chart

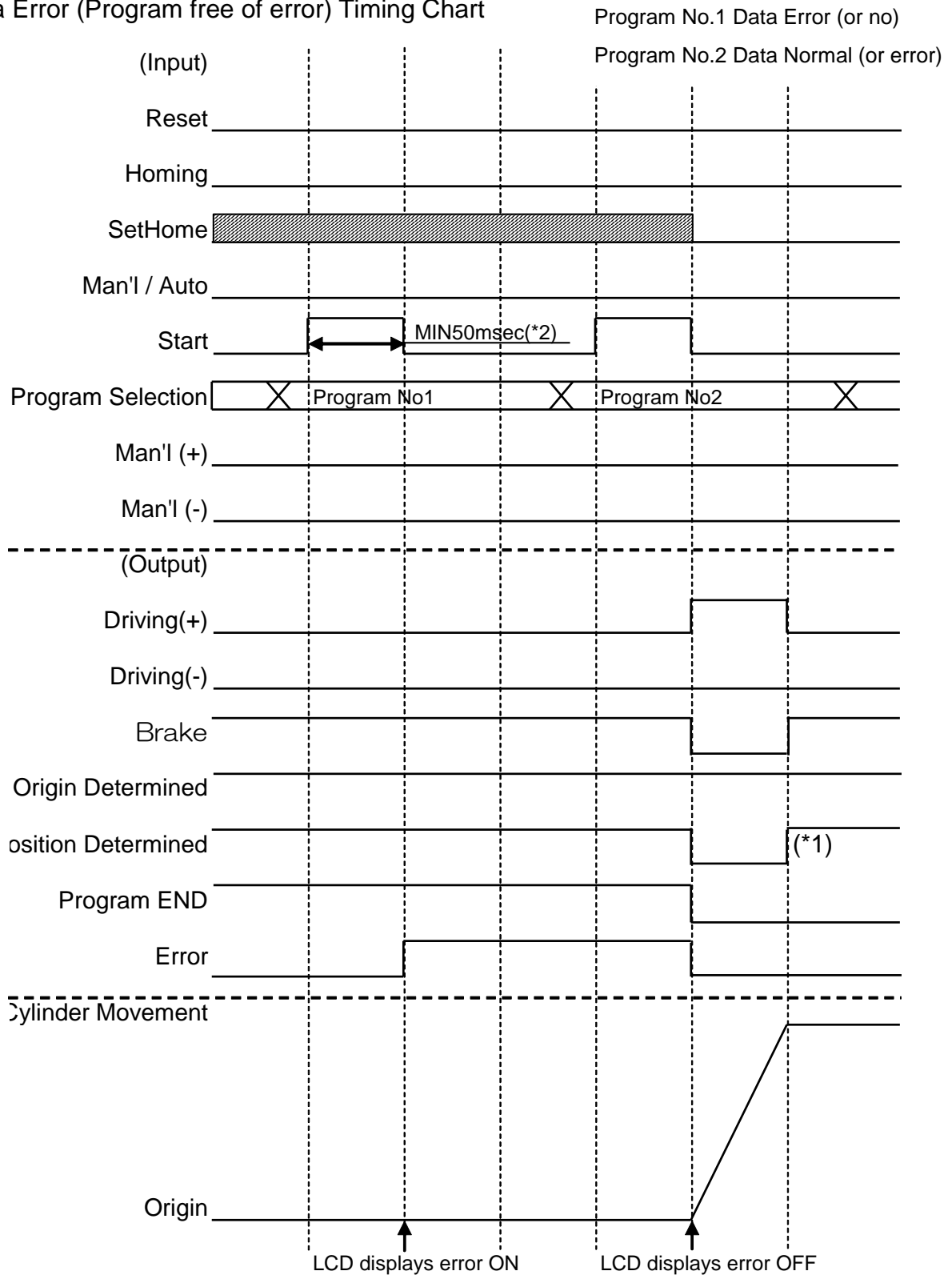

Note: When LCD displays error ON, press ON to clear the error.

Therefore, it is quite different from error output.

Data error will be recognized while the first step is executed.

(*1)Timing from stopping till output is 0.2sec (max).

(*2)Refer to P.27 7-3-6 Sequencer

9. Data Setting

9-1 Data Presetting

9-1-1 Data Classification & Content

- P1—Cylinder Stroke _____ Input stroke.
 P2—Tolerance _____ Input positioning tolerance range. Retries will assure the positioning within the tolerance range.
 P3—Retries _____ Input no. of retries. Maximum retries will be 9. Since Err9 (positioning error) will appear and the system will stop when positioning is not able to be set within the range, it is advisable to set the max. retries no.
 P4—Bore Size _____ Input cylinder bore size.
 P5—Load Rate _____ Input the load rate (the amount of correction for load against the movement of cylinder rod). Use formula as shown below: -

$$\text{Load(N)} \div \frac{\text{Bore size(m)} \times D^2 \times \pi \times \text{Operating Pressure(Pa)}}{4}$$

<Eg.> Bore size: 40(⇒0.04m) Load: 200N (Allowable kinetic Energy)

Operating Pressure: 0.5MPa(⇒5×10⁵Pa)

$$200 \div \frac{0.04 \times 0.04 \times 3.14 \times 5 \times 10^5}{4} \times 100 = 31.8 = 30\%$$

↑ Round-off

P6—No. of Brake operation

P7—Origin Detection Time

Set the Origin Detection time (t1).

(10ms as 1 unit, maximum will be 9.99s)

After inputting the homing (returning to origin)'s signal, if sensor does not receive any signal within t1 (situation whereby the cylinder stops), this reflects homing is achieved.

Setting of response time should take into consideration of load, mounting condition, tubing length, etc. The response time should be re-calibrated. If the operating conditions change.

When controller dip switch No.1, is set at ON, homing will be confirmed in addition that the auto switch is ON.

P8—Err12 (Operating Error) confirmation time, t2.

* Input Err12's decision time.

* 10msec as 1 unit. Max. will be 9.99sec.

* Within the time frame, if there is no signal feedback by sensor (cylinder stops) after inputting of start's signal. Err12 will be reported.

* Setting of the detection time should take into the consideration of load, mounting condition, tubing length, etc. If the operating conditions change, re-calibrate the detection time.

9-1-2 Input Method

Turn the controller switching mode to RESET.



P1 will blink.



Blinking

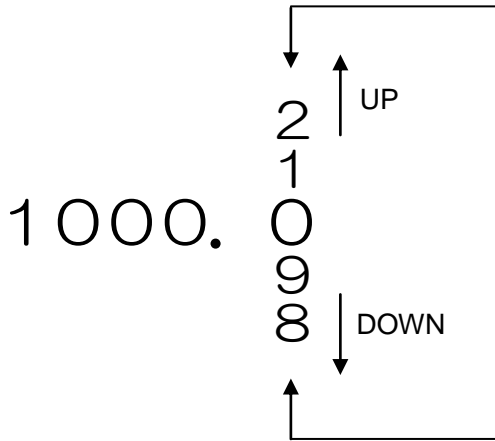

Blinking

<Reference>

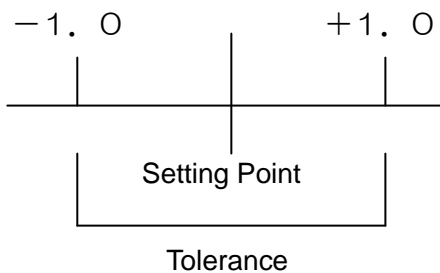

Blinking

Press either READ or WRITE to proceed to the input condition for cylinder stroke setting. The first decimal point will start to blink.

Use LEFT and RIGHT buttons to select digit to be changed and set the digit to the desired setting through UP and DOWN buttons. With that, input desired cylinder stroke.

After setting of cylinder stroke, press WRITE to switch to the next input condition. The display will indicate PRG STEP P2 and the current tolerance setting. At the same time, the first decimal point will start blinking.

Next, enter the desired tolerance value as in above mentioned method. The maximum possible input value is 9.9mm.

With input of tolerance, 1.0, any point fall between the set point ± 1.0 will be accepted. If the attempt falls outside the range, retries will perform to get into the required range.

If the required position is not achieved within the maximum retries, positioning error (Err9) will be shown.

After setting of tolerance range, press WRITE to switch to the next input condition. The display will indicate PRG STEP P3 and the current maximum retries.

Next, enter desired maximum retries. The maximum possible input value is 9.

During initial setup, predictive control is executing. Hence, it is suggested to set the maximum retries to 5 or above.

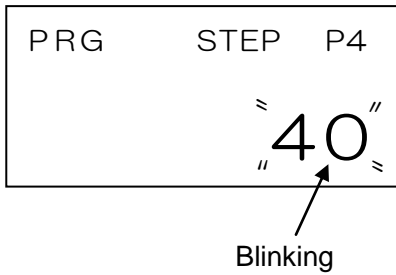

After setting of maximum retries, press WRITE to switch to the next input condition. The display will indicate PRG STEP P4 and the current cylinder bore size, which is blinking.

Next, enter appropriate cylinder bore size.

Setting value will vary as shown below.

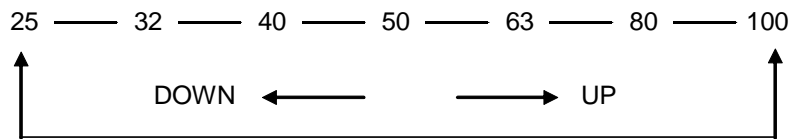

Note:

Monosashi-kun with Brake (CE2)'s bore size setting range from ϕ 40 to ϕ 100.

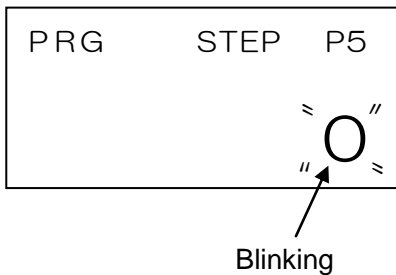

After setting of cylinder bore size, press WRITE to switch to the next input condition. The display will indicate PRG STEP P5 and the current load rate, which is blinking.

Next, enter correct load rate.

<Calculation>

$$\text{Load} \div \text{Cylinder Pushing Force} \times 100$$

Setting value will vary as shown below.

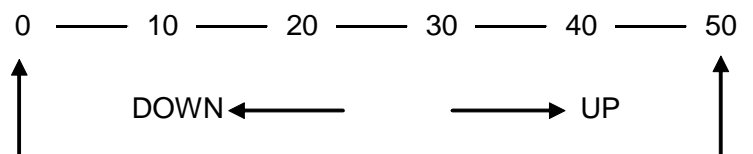

No blinking.

After the above setting, press WRITE to switch to the next input condition.

The display will indicate PRG STEP P6 and the current number of brake operation

The display number shows the operation number of brake assembly that had been activated. 1 unit represents 10,000.

Setting is not required.

Note:

Change the brake assembly, when the counter reaches 300.0.

(refer to P.41 11-2)

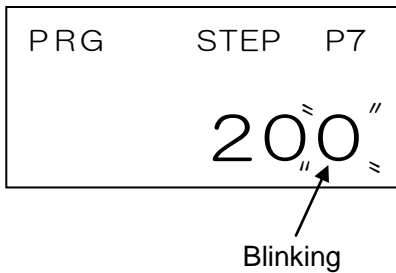

After reviewing of number of brake operation, press WRITE to switch to next input operation. The display will indicate PRG STEP P7 and present origin detection time.

Next, enter desired origin detection time. The setting range is 0~9.99sec (1 unit as 10msec). Set the date with taking into the consideration of cylinder operating conditions.

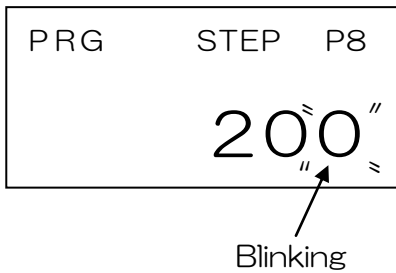

After the above setting, press WRITE to switch to next input operation. The display will indicate PRG STEP P8 and present operating error detection time.

Next, enter desired operating error detection time. The setting range is 0~9.99sec (1 unit as 10msec). Set the data with taking into the consideration of cylinder operating conditions.

After the above setting, press WRITE to end the whole preset operation.

9-1-3 Confirmation of Set Data

Turn the controller switching mode to PRESET.



← When P1 is blinking, use UP & DOWN key to reconfirm each and individual preset value.

← When the input value is blinking, press READ once to shift the operation back to P1.

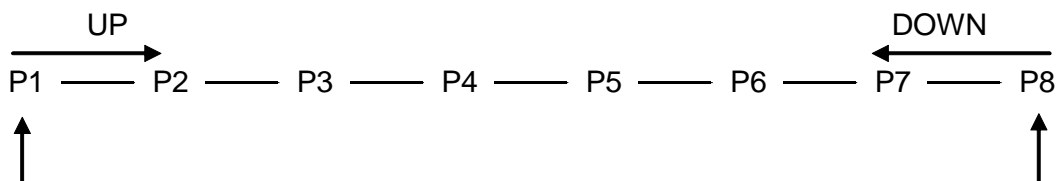

9-2 Program Setting

Input desired cylinder positions.

9-2-1 Input Method

Turn the controller switching mode to PROGRAM.

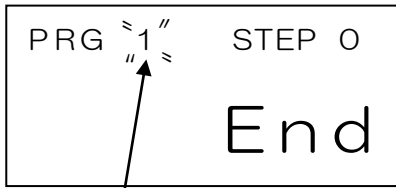

点滅

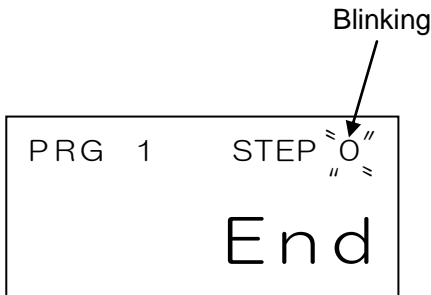

Blinking



Blinking



Blinking

Note:

Step 0 for every program is END.

Program no. "1" will start blinking.

Set the program no. through UP & DOWN buttons.

Program No.

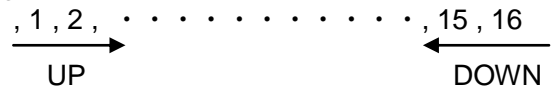

After above setting, press WRITE to end the operation. Step "0" starts to blink.

Next, press either READ or WRITE to proceed to next stage.

The display "End" will be replaced by "0000.0", leading to the input STEP 1.

Input first setting position into STEP 1.

Then, press WRITE to proceed to STEP 2.

Set the following setting positions.

STEP by STEP.

After inputting the last data into last STEP, press WRITE, and then END to end the program setting.

Note:

Controller will show Err7 during operation, if END is not inputted at the end of program.

With above mentioned inputting steps, input program shown below: -

<Input example>

Step \ Program	P1	P8
S1	50.0	68.0
S2	300.0	30.5
S3	30.0	
S0	End	End

Turn the controller switching mode to PROGRAM.

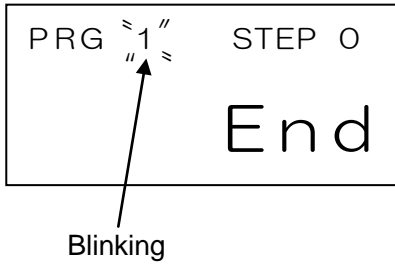

Press WRITE 2 times.
The display "End" will be replaced by "0000.0", leading to the input STEP 1.

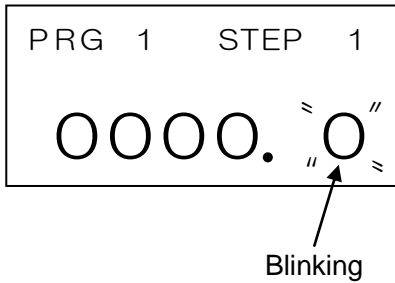

Press LEFT 2 times.
Blinking is shifted to "0", the first decimal point.

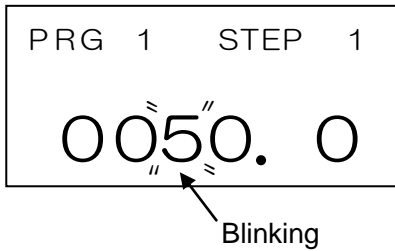

Press UP 5 times to set value of 5.

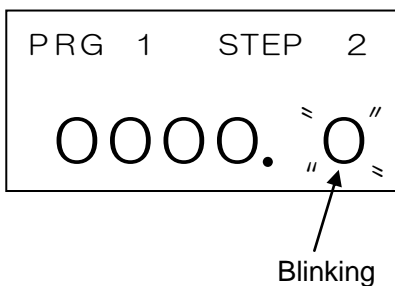

Press WRITE one time.
Press LEFT 3 times to shift the blinking cursor.

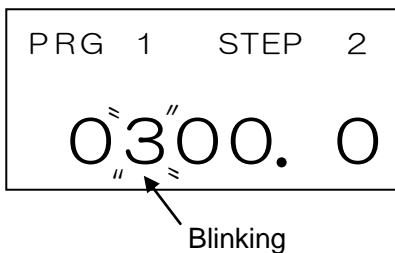

Press UP 3 times to set the value of 3.

PRG 1 STEP 3
0000.0

Blinking

PRG 1 STEP 3
0030.0

Blinking

PRG 1 STEP 4
0000.0

Blinking

Blinking

PRG 1 STEP 1
0050.0

Blinking

PRG 1 STEP 1
0050.0

Blinking

PRG 8 STEP 0
End

PRG 8 STEP 1
0000.0

Blinking

Press WRITE one time.
Press LEFT 2 times to shift the blinking cursor.

Press UP 3 times to set the value of 3.

Press WRITE one time to enter into program STEP 4, which is the end of program 1.
Press END to end the program setting for program 1.

Program 1's programming ends.

Set the program no. to 8 through UP to PRG "8".

Press WRITE 2 times.
The display "End" will be replaced by "0000.0", leading to input STEP 1.



Blinking

First, press LEFT one time.
Next, use DOWN to set the value of "8".

Press LEFT one time.
Then, use DOWN to set the value of "6".



Blinking

Press WRITE one time.
Press UP 5 times to set the value of "5".



Blinking

Press LEFT 2 times.
Press UP 3 times to set the value of "3".



Blinking

Press WRITE to enter input STEP 3, which is the end of program 8.
Press END to the program setting for program 8.

Blinking

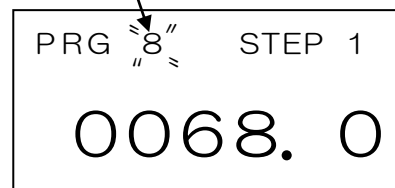

Program 8's programming ends.

9-2-2 Confirmation of Input Data

Turn the controller switching mode to PROGRAM.

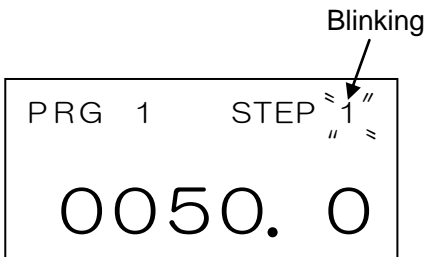

When PRG "1" is blinking, use UP & DOWN to select desired program to be checked.
Next, press READ to proceed to the specified program's STEP "1".
Then, use UP & DOWN to check and confirm every step.

9-3 Selection of Dip Switch

No.1···The Identification of Origin

OFF····When cylinder stops, if there is no signal feedback from sensor within t1 (Preset data,P7), counter value will be reseted to “0” and origin is obtained / recognized.
Generally, origin will be at the stroke end.

If origin is set within the stroke, install stopper with respect to the origin.

ON····When the cylinder stops at origin, situated at the location where auto switch or limit switch is, and sensor signal is not feedback within t1, counter value will be reset to “0.0” and origin is obtained.

Install the origin wire to terminal 10.

No.2···The Setting of Braking System

OFF····In this state, ON means brake is activated. OFF means brake is in releasing state.

If power supply of controller is cut off, the brake will be in releasing state.

If cylinder is mounted horizontally and the air balance is not achieved, when power is cut off, the cylinder may keep moving in and out.

If cylinder is mounted vertically, when power is cut off, cylinder rod will fall to the bottom end, due to its own weight.

ON····In this state, OFF means brake is activated, ON means brake is in releasing state.

If power supply of controller is cut off, the brake will be in clamping state.

Note: Please take note at piping, which may lead to opposite setting.

No.3···The Change of Counter Direction

OFF····The extend direction will be an increment on counter.

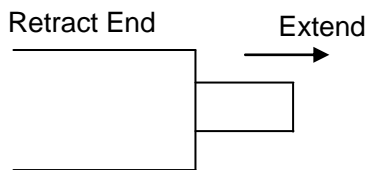

The origin is set to be at the retract end.

ON····The retract direction will be an increment on counter.

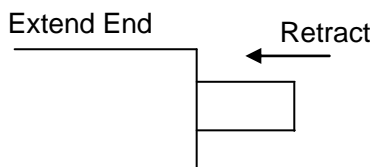

The origin is set to be at the extend end.

Note: Please take note at wiring as it may result to opposite setting.

No.4···Deletion of Memory: Delete all the input data, back to the initial state.

Generally, set the state to OFF. If input data is required to be deleted, set the state to ON. Next, reset the power supply through terminal 13. After achieving the initial state, set the state back to OFF.

10. Driving

10-1 Setting of Origin Direction

Location's detection method used by Monosashi-kun with brake cylinder is incremental method. Please set the origin and reference accordingly.

Cylinder stroke end, either extend end or retract end, will be the origin. When dealing with cylinder with cushion, please do not over monitoring the cushion effect.

When stopper is used, please use shock absorber to prevent from the occurrence of impact and “spring back” effect.

10-2 Adjustment of Air Balance

Due to the stoppage precision, the rate of occurring of abnormal operation, etc. Will be greatly affected by the stability of air flow. Please monitor closely to achieve air balancing of cylinder.

Adjustment

- 1 Manually operate the controller or directional valve & brake valve to shift the piston rod to the center of stroke.
- 2 Release the brake and carry out adjustment through pressure reducing valve. Remember, piston rod should not move during adjustment. Release the brake through brake valve or controller dip switch No.2.
- 3 After completion of the adjustment, manually operate brake valve to release and lock the brake system for a few times. If piston rod is moving during operation, redo the adjustment.
- 4 Lastly, check it with testing the attainment of desired location.

If piston rod moves to the extreme end or with extraordinarily speed, redo the above adjustment.

Note: If the braking assembly unit has been changed, reset the controller.

11. Error Messages & Countermeasures

11-1 Controller

Err1: Sub-CPU's ROM, RAM Error

Content : During power supply to sub-CPU is on, ROM or RAM is found faulty.

Solution : Reset & Retry.

Countermeasure : After resetting, if error occurs again, ROM. RAM may have faulty. Change ROM.RAM.

Err2: Main-CPU's ROM, RAM Error

Content : During power supply to sub-CPU is on, ROM or RAM is found faulty.

Solution : Reset & Retry.

Countermeasure : After resetting, if error occurs again, ROM. RAM may have faulty. Change ROM.RAM.

Err3: Battery Error

Content : During initial checkout, battery voltage less than 3.2V.
Input data can only be retained within 2 hours after the error detection.
Battery's life is 5 years from the purchasing data.

Solution : Press ON (UP & DOWN).

Countermeasure : Change battery. After changing, verify input data. If data has been deleted, re-input. After resetting, operation of cylinder is still possible.
However, during operation. LCD display will show that "PRG" is blinking. With the power supply ON, data can be retained as long as 2 hours, after the error message appears. Therefore, do not cut off power supply, even during interchanging of battery.

[Replacement in Japan]

The part No. of the replacement battery assembly is CEU2-H0125.

Please refer to the Battery assembly replacement procedure CE*-OMM0038-* for replacement. Or please prepare a battery equivalent to the following conditions and purchase a replacement battery holder assembly

(Part No.: CEU2-H0446) from SMC. Please refer to the Battery assembly replacement procedure CE*-OMU0014-* for replacement.

[Replacement outside Japan]

Please prepare a battery equivalent to the following conditions and purchase a replacement battery holder assembly (Part No.: CEU2-H0446) from SMC. Please refer to the Battery assembly replacement procedure CE*-OMU0017-* for replacement.

Battery specifications

- Type: Lithium thionyl chloride battery
- Nominal voltage: 3.6 V - Capacity: 2600 mAh
- Size: Refer to the figure on the right.

<Example>

SAFT lithium battery part number LS14500

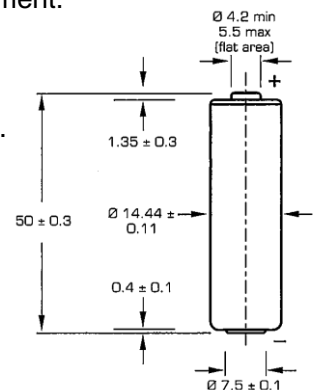

Err4: Backup Error
Content

: After power supply is on or Reset signal is inputted, backup checking is conducted, error is detected during output. Each and individual data is checked through backup checking. Once, error is detected, clear the error and at the same time, data will be deleted too.

Err41···Preset Data Error

When this error appears, input data will be deleted. Re-input is required.

Err42···Program Data Error

When this error appears, input position's data will be deleted. Re-input is required.

Err43···Learning Data Error

When this error appears, learning data will be deleted and lead to the operation of predictive control (retries will perform again).

When errors appear, re-entry of data is required.

Solution

: Press ON (UP or DOWN).

Countermeasure

: Check below 5 points and execute accordingly.

- 1 Check whether reset is executed during the execution of controller or during motion.
Besides that, please verify wiring and sequence of the program.
- 2 Verify whether AC100V's deviation is within the tolerance level, $\pm 15\%$ (AC85~115V).
- 3 Verify the power supply (AC100V) has been toggled within 20ms.
- 4 Check whether controller's FG (frame ground) is being connected to earth.
- 5 Verify that there is no moving signal feedback from sensor while the power is being cut off.

Err5: Data Error
Content

- 1 During presetting of data, over stating the cylinder's stroke, or under stating the moving distance of cylinder (less than 5mm), error will be shown.
- 2 During operation, error will also appear, when moving distance is less than 5mm. However, if the stop position is still within the tolerance of next setting point, stop point will be determined and accepted.

<Example>

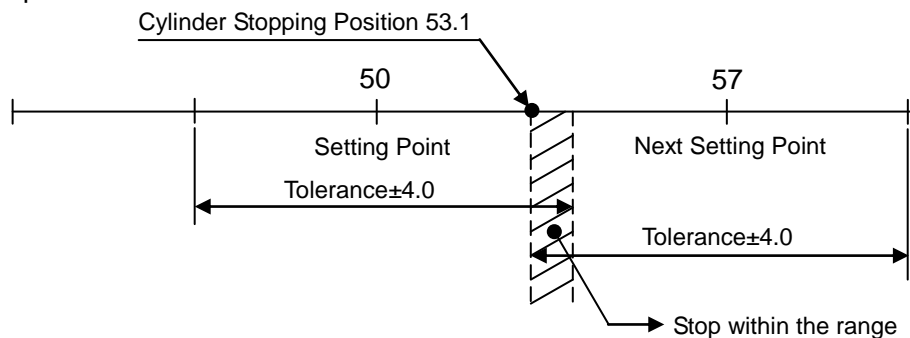

After inputting start, cylinder will stop at the position.

Solution

: During programming, press ON (UP or DOWN).
During moving state, press either ON or RESET.

Countermeasure

: If situation 1 and 2 occur, please change the program accordingly.

Err6: Learning Error
Content

: The stopping position is before the braking position.

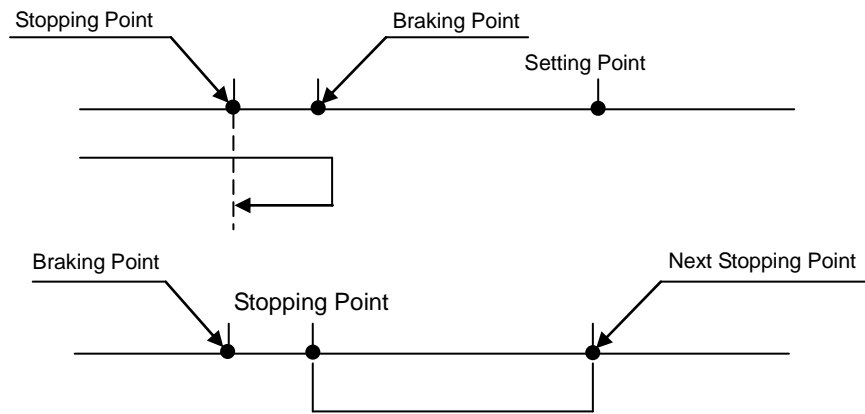

There is no braking point within the moving distance.

Solution Countermeasure : Reset or re-providing power supply.
 : Verify air balancing.
 Verify whether there is any impact or momentum acting upon cylinder during positioning. Verify that there is no entanglement or twisting.
 Due to the momentum at the stroke end, setting of "0.0" as origin will lead to high occurrence of errors.
 Therefore, set the origin within "1.0~5.0". Besides that, it is advisable to make sure that cylinder rod should return to origin at the end of operation.
 For cylinder with cushion, due to drastical change of speed within the stroke, learning error may arise.
 Therefore, for the case of stopping position within 30mm from stroke end is required, it is advisable not to utilize cylinder with cushion.

Err7: No Program Content

: There is no program being selected.
 Program NO., which does not have any contents, is selected.

Solution Countermeasure

: Press ON or Reselect program.
 : Verify input.
 Verify selected program, wiring or sequence of program inputted.
 After the occurring of Err42, program will be deleted.
 Please re-enter program.

Err8: Homing Error Content

: When dip switch No.1 is set ON, error will show if homing is not performed.
 When cylinder stops and limit switch at origin is still ON, homing will be detected.

Solution Countermeasure

: Reset or Retry.
 : Ensure the origin detection switch is functioning (switch is on when cylinder rod is at origin).
 Ensure wiring is connected properly.
 Ensure input signal sent by auto switch is fed to terminal 10 through input monitor (red LED).
 Ensure there is no twist at guide.
 During the movement of cylinder rod, ensure that it will not stop within origin detection time.

Err9: Positioning Error Content

: Accurate positioning was not performed within specified preset retries (Preset Data, P3) or preset tolerance (Preset Data, P2).
 When Err9 occurs, there are 2 possibilities of errors.
 First error due to Err9. Secondly, it may due to abnormal stoppage position.
 Recognize the errors, so as to execute accurate remedy.

- Solution : Press either ON or RESET.
 When ON is used to remedy situation, next program step will be executed.
 However, Err5 will occur if the stopping position when Err9 occurs, is less than 5mm away from the next program step's specified value. In this case, homing should be done. Restart the program.
 When RESET is used, homing will be performed and operation will go back to initial state, program step No.1 and restart.
- Countermeasure : Ensure there is no variation on load or pressure.
 Ensure air balance state. Ensure there is no twist at guide.
 Ensure there is no momentum and impact acting on cylinder while positioning is performed.
- Err10: Emergency Stop
 Content : Display shows emergency stop.
 Solution : Disable the emergency stop signal.
- Err11: Processing Error
 Content : Processing error by Sub-CPU is detected.
 Solution : Reset or Retry.
 Countermeasure : If error re-occurs, change the controller.
- Err12: Operating Error
 Solution : Press either ON or RESET.
 Countermeasure : Ensure there is no twist at guide.
 During the movement of cylinder rod, ensure that it will not stop within operating error detection's time. Re-adjust operating error detection's time.

11-2 Brake Unit's Life Span

Change the brake unit, when life span of 2 million cycles has been achieved. Check its life span through the following method: -

- Check the lock pin's check gap dimension.
 - Check through controller preset data (P6), which records the brake's operation cycle No.
- * Check the lock pin. When check gap, L, is 1mm or less, change brake unit

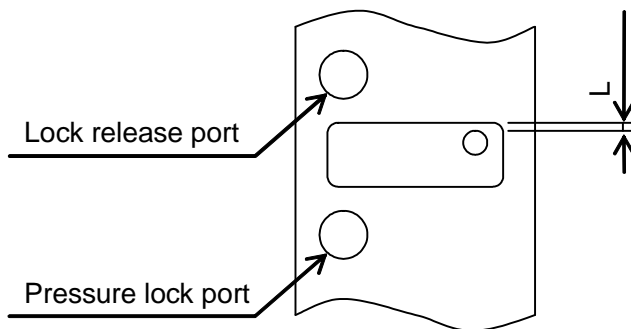

* Check the controller. When the value of 200.0 is reached, change brake unit.



The 2 million cycle life span assumes following conditions:

- Piston speed : 300mm/sec
- 50% load or less when horizontally mounted.
- 35% or less when vertically mounted.
 (Within allowable kinetic energy range.)

12. Appendix

12-1 Data Sheet

●Parameter

Preset Data

No.	Data Name	
P1	Cylinder Stroke	
P2	Tolerance	
P3	Retries	
P4	Bore Size	
P5	Load Rate	
P6	No. of Brake Operation	
P7	Origin Confirmation Time	
P8	Err12's Confirmation Time	

Dip Switch Setting

No.	Setting	
No.1	OFF	ON
No.2	OFF	ON
No.3	OFF	ON
No.4	OFF	ON

●Program Data (Determined Position Data)

Program Step	1	2	3	4	5	6	7	8
1								
2								
3								
4								
5								
6								
7								
8								
9								
10								
11								
12								
13								
14								
15								
16								
17								
18								
19								
20								
21								
22								
23								
24								
25								
26								
27								
28								
29								
30								
31								
32								

Step \ Program	9	10	11	12	13	14	15	16
1								
2								
3								
4								
5								
6								
7								
8								
9								
10								
11								
12								
13								
14								
15								
16								
17								
18								
19								
20								
21								
22								
23								
24								
25								
26								
27								
28								
29								
30								
31								
32								

Revision history

G: Revise Safety Instructions.
Add Wiring diagram of Transmitter box and Receiver box.
Other term correction. (January 2019)

SMC Corporation

4-14-1, Sotokanda, Chiyoda-ku, Tokyo 101-0021 JAPAN

Tel: + 81 3 5207 8249 Fax: +81 3 5298 5362

URL <http://www.smcworld.com>

Note: Specifications are subject to change without prior notice and any obligation on the part of the manufacturer.
© 2011 SMC Corporation All Rights Reserved